

SHOW NUMBER

September 17

15
Cents

RADIO

REG. U.S. PAT. OFF.

WORLD

America's First and Only National Radio Weekly

KNICKERBOCKER FOUR

UNIFIED DIAMOND

THE STROBODYNE

PEDESTAL 36" CONE

A 5,000 MFD. CONDENSER

COILS INGENUOUSLY SIMPLIFY TUNING

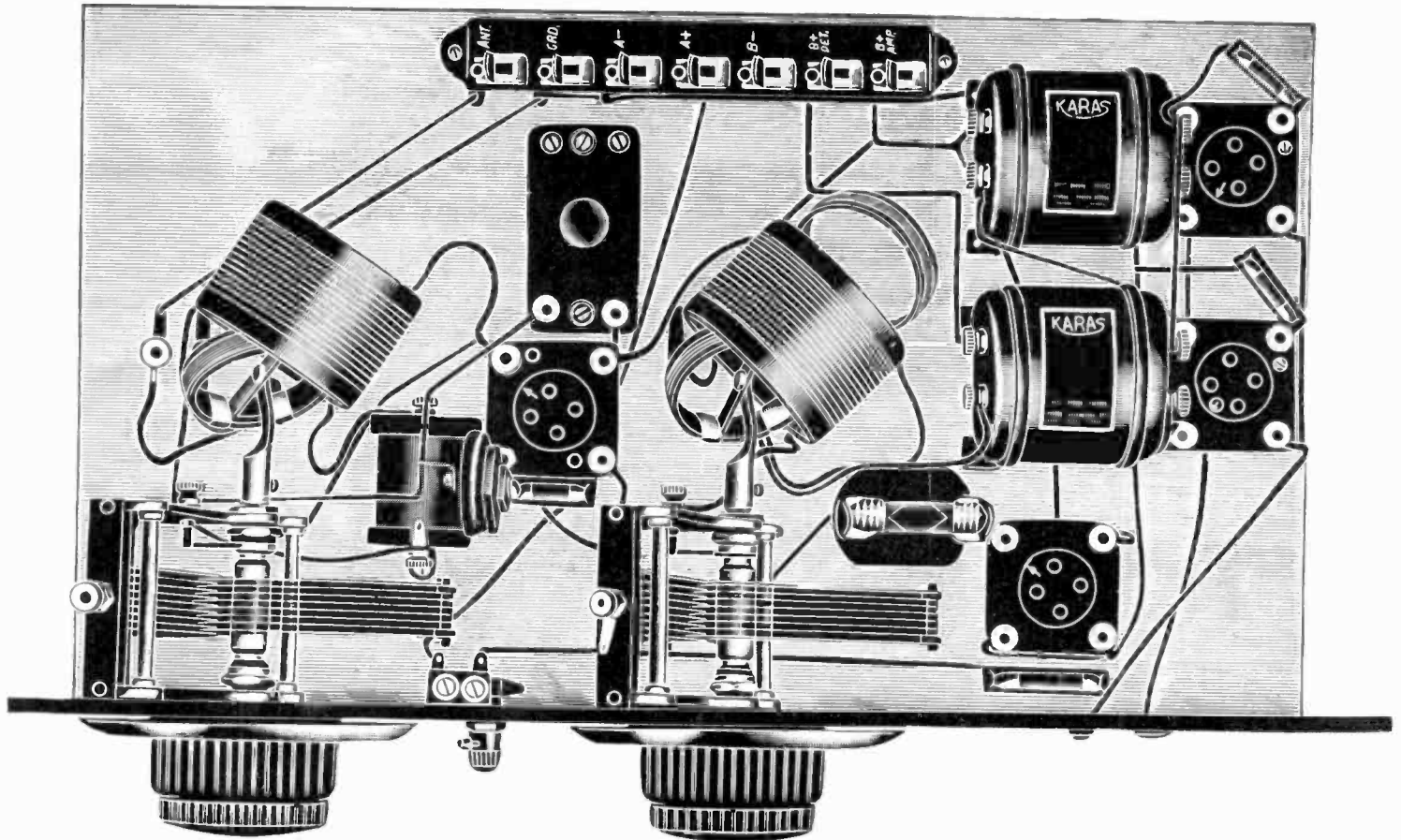

THE KNICKERBOCKER FOUR, showing in detail the placement of parts that go into the receiver. The simplicity of the arrangement and the discriminating choice of parts ensure sensitivity without oscillation, quality without distortion. The two rheostats are not shown. See Page 3.

LIST OF STATIONS

NEW 4-ELEMENT TUBE

THE RADIO "WE"

THE WITZ SINGLE TUNER

EFFICIENCY ON VICTOREEN

FREQUENCY KEPT CONSTANT

BUILD THE STROBODYNE

acclaimed by set builders—

RADIO'S GREATEST CIRCUIT

THERE are few instances in Radio where popularity has been so swiftly and easily gained for a circuit than in the case of the "STROBODYNE."

The first Set Builders to grasp the marvelous basic principle of the "STROBODYNE" system and immediately assembled the receiver praise the circuit without reservation.

A few of the many letters we have received are printed on the right.

The following are but a few of the features which have been developed to an unusual degree in "The Stroboddyne":

- (1) Extreme selectivity enabling you to tune out interference.
- (2) The ability to receive distant stations as a matter of course, rather than as an event.
- (3) Unusual tone quality due to the precision and quality of the apparatus used.
- (4) All the volume you want—undistorted.
- (5) Extreme simplicity of tuning and adjustment.
- (6) Easy to build and every product fully guaranteed.



The products of the well-known manufacturers below have been combined to make the STROBODYNE a circuit of sensational performance.



- 3 Hammarlund Variable midline condensers .00035 mf.
- 1 Set Hammarlund Stroboddyne coils
- 3 Hammarlund Shields
- 3 Hammarlund Equalizing Condensers
- 1 Hammarlund Brass Shaft 10 1/4" long
- 2 General Radio Audio Transformers
- 1 General Radio R.F. Choke
- 4 Radio Electric Lab. R.F. Units Type F
- 5 Radio Electric Lab. Fixed Matched Condensers
- 1 Micarta Fabricator Panel 8" x 24" x 3/16"
- 1 Micarta Fabricator Sub Panel 12" x 25 1/4" x 1/4"
- 1 Muter Clarifier (output filter)
- 3 Carter No. M-20 Midset Rheostats 20 ohm
- 1 Carter No. M-400 Midset Potentiometer 400 ohm
- 1 Carter No. 1 Short Jack Open Circuit

- 1 Carter No. 2A Short Jack Closed Circuit
- 1 Carter Imp Battery Switch
- 1 Cardwell Balanced Type 618A
- 1 Dubilier By-Pass Condensers .5 mf. Type 907
- 1 Dubilier Fixed Condenser .002 mf. Type 601
- 8 Benjamin Sockets UX Type 9040
- 12 X-L Binding Posts
- 2 National Co. Dials
- 4 Amperites Type 1A
- 1 Amperite Type 112
- 1 Electrad Royalty Variable Resistance Type B
- 2 25 ft. coils Belden Colorubber
- 7 CeCo Vacuum Tubes Type 201A
- 1 CeCo Vacuum Tube Type 112
- 1 Fritts Cabinet for Panel 8" x 24" x 12 1/4"

Address All Inquiries to "STROBODYNE," 230 Fifth Ave., New York

What Some STROBODYNE

Builders Say

"Using an antenna about 150 feet long and 20 feet high I picked up KFI, Los Angeles at 12 midnight each night for 9 days. Not bad for summer. WJZ and WGY come in with terrific loudspeaker volume on one audio stage. I'm going to build a friend a set using specified parts. I guess he'll get the South Pole, as he has an aerial 50 feet high. I've built every set known, but the STROBODYNE is the best every way and has about twice as much volume."

W. G. COREY,
7312 Bennett St.,
Pittsburgh, Pa.

"I have constructed the STROBODYNE and I want to let you know of the results I have had with it. I have used it for only 3 nights and last night I brought in WDAF, Kansas City, with tremendous volume on the speaker. All speech could be easily understandable at 150 feet away from the speaker. This same station (WDAF), when brought in on a set using three stages of tuned R.F. det. and two audio and working properly, was barely audible on headphones using all six tubes.

"I have constructed several supers and I can easily say that the STROBODYNE is the greatest circuit without question.

"My aerial is a single wire 65 feet long and 3 stories high at the near end and one story at the far end. It is almost entirely killed by 3-story brick buildings on all four sides, but I got WDAF, WGY, both with the same volume and excellent tone through five local stations with no interference at all."

CHESTER KELLEY,
1231 No. LaSalle St.,
Chicago, Ill.

"Have just completed the STROBODYNE receiver; it is working fine. The volume is great and it is very powerful."

H. LEONARD WILSON,
239 Gradman,
Cincinnati, Ohio.

Fill Out and Mail This Coupon NOW!

"STROBODYNE"
230 Fifth Ave., New York

I enclose 50c. for one copy of the official construction book, giving all data on the STROBODYNE, and all supplementary information.

Name

Address

City

State

[Entered as second-class matter, March, 1922, at the post office at New York, N. Y., under Act of March, 1897]

The Knickerbocker Four

Ingenious Coupling Device Used With Efficient Parts Makes a Remarkably Sensitive Receiver

By Herbert E. Hayden

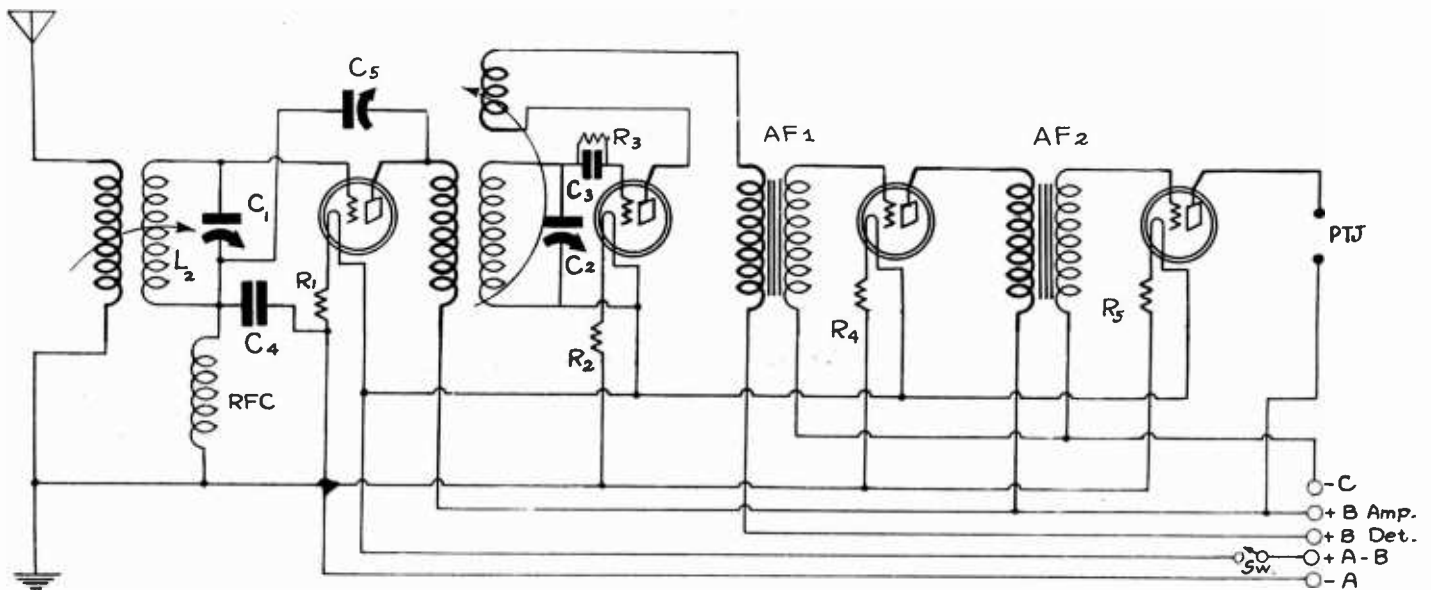

THE CIRCUIT DIAGRAM of the Knickerbocker Four, a remarkably sensitive, distance-getting, voluminous tone quality set. "Maximum of results with a minimum of apparatus" might well be the slogan of the sponsors of this circuit. R1 and R2 may be rheostats for volume and sensitivity control, while R4 and R5 are Amperites.

[Here is a four-tube circuit that is truly outstanding. Operated by the author, an old-timer in radio and likely to be hard-boiled, it threw him into ecstasies of delight. He has a DX hankering. He got DX aplenty, and in August, too! Tone, volume, simplicity, ease, accuracy, economy. "All these are mine," he said, corroborating the report of Robert Hertzberg, a prior investigator, who said of the Knickerbocker Four: "This is some set."—Editor]

THERE is no longer any need of tolerating squeals in a regenerative radio receiver. There is no need for sacrificing the amplification on the longer broadcast waves just to gain stability of the receiver at the shorter waves. There is no need of taking the hands off the tuning dials in order to manipulate one or more oscillation controls. In the Knickerbocker Four the oscillations are controlled automatically as the condensers are turned, and the control is just right at all settings of the condensers.

The basic circuit used in the Knickerbocker Four is well-known and has been tested out thoroughly. It is the one four-tube circuit which gives more volume and greater distance than any other four-tube receiver. It employs one stage of tuned radio frequency amplification, a regenerative detector and two stages of transformer coupled audio amplification.

Three Distinguishing Features

The distinguishing features in this application of the well-tried circuit lie in the system used for preventing radio frequency oscillations and in the parts se-

lected. The tuning condensers are of the straight line frequency type so that the stations come in at points on the tuning dials which are spaced in the same proportion as the broadcast channels are spaced in the frequency spectrum. The dials used are so geared, without any backlash, that the separation of the stations can be effected with greatest ease. The ratio is 64-to-1. The main feature of the circuit is the fact that the tickler is mounted on the condenser shaft and regeneration is obtained without an extra control.

An extension shaft is put on each condenser and the primary of the first coil is placed on the shaft. This primary is in the antenna circuit. The plane of the primary coil can be set at any angle with respect to the shaft. If it is set at right angles the condenser can be turned through 180 degrees without changing the coupling between the primary and the secondary in the slightest degree. If the plane of the primary is set nearly parallel

THE construction of the Knickerbocker Four is discussed herewith. Tuning skill is easily acquired and DX rolls in. Read the details in next week's issue, dated September 24.

with the shaft of the condenser, the coupling variation is very great as the condenser is turned.

The variable coupling is not confined to the primary alone. The secondary also can be turned and set at any angle with respect to the primary. It can also be moved to and from the primary, thereby varying the distance between the coils for any given angular setting.

Great Flexibility

The coupling is so flexible that the operator can choose any type and any degree of coupling he desires, from extremely close fixed coupling to very loose fixed coupling; and from very close to very loose variable coupling. No tools, except possibly a screwdriver, need ever be used in varying the coupling from one type to another.

All these various degrees of coupling cannot be had with the same degree of stability, sensitivity or selectivity. The circuit obeys all the regular laws despite the flexibility of the coupling. The advantage of the special coupling lies in the choice that is available to the operator. Naturally he will choose the optimum coupling. In other words, the coils can be so adjusted as to give maximum reception for any location. One will not choose close coupling and squeals; neither will he choose extremely loose coupling with weak signals. He will select maximum amplification consistent with stability.

One of the chief advantages of the coupling arrangement is the reciprocity relationship existing between it and the behavior of inductive coupling. As is well known, the energy of one coil induced in another is proportional to the frequency as well as to the mutual inductance. In fact, the transfer is proportional to the product of the two. If the mutual inductance between two coils remains constant as the frequency is increased, the inductive quantity increases as the frequency increases.

If we had some means of reducing the mutual inductance between the two coils in the same proportion as the frequency increases, the energy induced would be the same for all frequencies, that is, for all settings of the tuning condenser.

That is exactly what can be done with the variable coupling in the Knickerbocker Four!

If the secondary coil is placed in a given position, the angle the primary makes with the shaft can be adjusted so that the mutual inductance between the two windings decreases in the same ratio that the frequency of resonance of the circuit increases. That is, so that the energy transfer remains constant throughout the broadcast scale.

The sensitivity of the circuit will therefore be the same for all frequencies. If the two coils are so placed at one frequency that it squeals, it will squeal at all other frequencies. If the coils are so placed that there is no squealing at one frequency there is none at any frequency.

Goal to Seek

The most desirable placement of the coils is such as will give highest sensitivity over the entire band without any oscillation at any point. The circuit should be just below the oscillating point over the entire range. This is an ideal toward which the operator should strive in his adjustment of the coupling. The ideal can be approached very closely with a little experience.

Regeneration has been introduced into the receiver to make it 100 per cent. sensitive. The tickler coil occupies the same position on the shaft of the second condenser as the antenna coil does on the first. What was said regarding the primary in connection with that coupler applies also to the tickler in the second. The tickler really is a kind of primary winding in that it feeds energy into the secondary coil. The true primary coil, that is, the coil in the plate circuit of the

LIST OF PARTS

C1, C2—Two Karas Orthometric .00037 mfd. condensers.

One Karas antenna coupler to match C1.

One Karas three circuit coil to match C2.

AF1, AF2—Two Karas Harmonik audio transformers.

Sw—One Yaxley filament switch.

PTJ—Two Amsco pin jacks.

RF—One Samson 85 millihenry R.F. choke coil.

Cn—One Samson neutralizing condenser (.00003 to .0003 mfd.).

C3—One Sangamo .00025 mfd. by-pass condenser with clips.

C4—One Sangamo .0001 mfd by-pass condenser.

R3—One Amsco 2 megohm grid leak.

R1, R2, R4, R5—Two Yaxley 20-ohm rheostats; two 1A Amperites.

Two Karas Micrometric dials.

One 7x18x3/16 inch Micarta panel.

One wooden baseboard, 9 $\frac{1}{2}$ x17 $\frac{1}{2}$ x $\frac{1}{4}$ inch.

One Mucher binding post strip containing 7 Fahnestock clips.

Four Benjamin sockets.

first tube, is placed on a small form near the end of the secondary which is hinged so that the coupling can be adjusted and left in the best position. No knob for this variable is brought out on the panel however.

The coupling between the plate coil and the secondary can be made loose enough so that the circuit will not oscillate at any setting of the condenser. The tickler coil can then be adjusted with respect to the secondary so that the detector is just on the verge of oscillation at all settings of the tuning condenser without "spilling over" at any point.

A neutralizing condenser is used in preventing oscillation in the first tube when the coupling is made close. This condenser is connected between the plate of the first tube and the low potential side of the first tuner. This connection would simply make the condenser a small by-pass across the primary of the three-circuit coil were it not for the fact that an 85 millihenry RF choke coil has been interposed between the low potential side of the tuner and ground.

A small current of resonant frequency passes through the choke coil and the neutralizing condenser, the voltage drop across the choke due to this current opposes any oscillation. That is, it neutralizes. Now as the frequency increases the

voltage drop across the coil increases, and this makes the reverse feed-back more than enough to neutralize. It would dampen the circuit on the higher frequencies and render it insensitive. Hence a small condenser C4 has been connected across the choke coil. This helps to limit the damping on the shorter waves. The value of the condenser is only .0001 mfd.

As a further means of preventing oscillation, the secondary coils should be placed at such an angle that the magnetic coupling between them is zero. The correct angle is somewhere between 50 and 60 degrees. This means that the axes of the two coils should make this angle with the panel.

A .00025 mfd. Sangamo grid condenser provided with resistor clips is used in the detector. The grid leak used in these clips is an Amsco 2-megohm Gridgate.

The two audio frequency transformers have been selected with the view of getting an even amplification over the entire audible scale down to the lowest essential notes, with maximum amplification without distortion. The ample dimensions of the cores and the high inductance of the primaries insure the amplification of the lowest tones.

The layout of the Knickerbocker Four is extremely simple and its assembly can be effected in a couple of hours. No other tools than a screwdriver, a pair of pliers and a soldering iron are necessary.

Everything Made Easy

The panel for the set can be obtained drilled and marked for mounting of the condensers and the other parts. The simplicity of the arrangement can be seen from the photograph published on the front cover. At the left is the antenna condenser and coils. The RF choke and the small by-pass condenser are next in the same relative position in the receiver as it is in the circuit diagram. Next is the socket for the RF tube, and behind that the neutralizing condenser. So far everything has been placed with the view of making all leads short and direct.

The same idea has been carried out in connection with the three-circuit coil and its condenser which are placed in the middle of the set. The small coil placed on the shaft is the tickler while the small coil at the opposite end of the secondary is the primary coil. It is set for loose coupling.

The audio amplifier, coils and tubes are placed in the right rear corner of the set. The binding post strip is centrally located at the far edge of the baseboard, where it is easily accessible for connections both with the circuit and the power source.

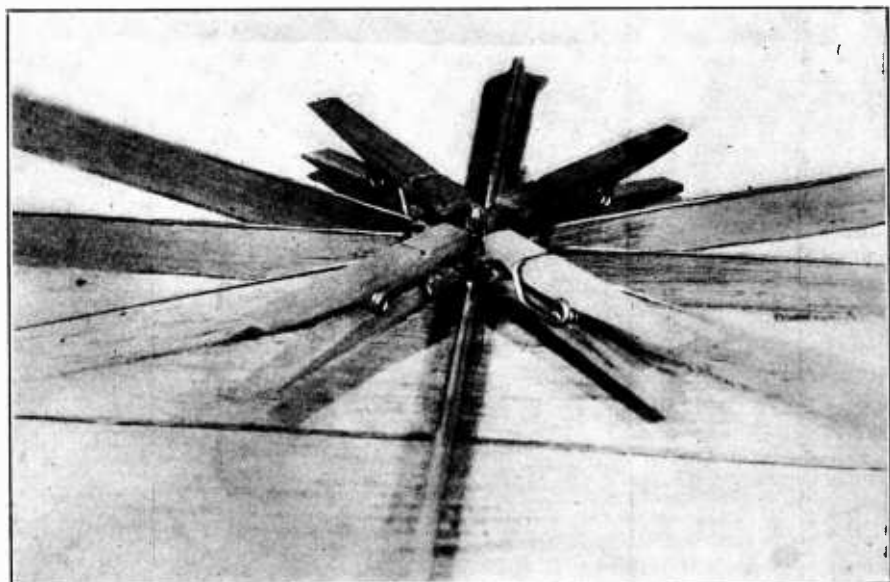

(Hayden)

IN MAKING a Lata Balsa speaker, be sure that the small center wooden piece is cemented securely. Clothespins may be used to hold the wood down, while the cement is drying.

Sometimes I'm Series— Sometimes I'm Parallel

My Disposition Depends on emf

By Franklin J. Edgecomb

SOMETIMES we speak of two impedances being connected in parallel and at other times we speak of them as being in series. Again we speak of a generator, a battery, a vacuum tube or a transformer secondary as being connected in series or parallel. The terms are often confusing. One says that the connections are parallel when some one else says they are in series.

What determines when they are parallel or in series?

Whether the connections are series or parallel depends on the location of the emf with respect to the impedances. Suppose we connect a resistance across a battery. Is the resistance in series or in parallel with the battery? The emf in this case is in the battery and anything that is connected across the terminals of the battery is in series with the emf.

If we connect two impedances or resistances across the terminals of the battery, these two are in parallel, but the two of them are in series with the battery.

If—and Then Some

If we substitute a generator for the battery the same rule holds. The emf is in the generator and anything that is connected across the output terminals of the generator is in series with the emf of the generator.

If we connect two impedances across the terminals of the generator these two impedances are in parallel but the two are in series with the emf.

Suppose we connect a transformer in the plate circuit of a vacuum tube—from plate to B plus. The primary of the transformer is in series with the plate circuit because the emf is located in the plate to filament circuit. If we connect two transformers similarly they are in parallel, but the two are in series with the plate circuit, or with the emf residing in the plate-to-filament circuit.

When we connect an impedance across the secondary of a transformer it is in series with the secondary because the emf is in that winding. Two or more impedances may be connected similarly across the secondary. When they are they are in parallel with each other but in series with the winding in which the emf is.

The Phonograph Pick-up

Suppose we connect the pick-up unit of a phonograph across the primary of a transformer by plugging in the detector socket. The tube is not a part of the circuit and the pick-up becomes the source of the emf. Hence the transformer primary is in series with the pick-up unit.

If the detector tube could also be inserted into the circuit and made operative at the same time that the pick-up unit is operative, there would be two sources of emf, and they would be in parallel.

If the detector tube alone is active and the pick-up is merely idling, the pick-up constitutes a load on the detector tube

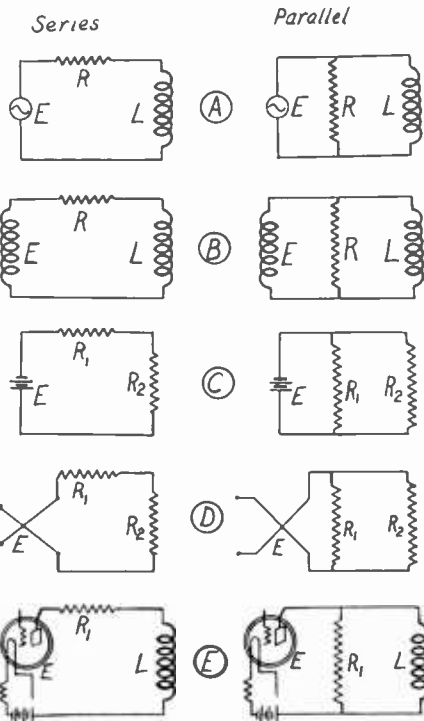

VARIOUS types of emf sources with series and parallel connections of load impedances.

and it is then in parallel with the transformer primary. This change can be affected by merely lifting the pick-up unit off the record.

The question of series and parallel connections is troublesome at times in tuned circuits. Ordinarily we have a radio frequency transformer with a tuned secondary between two tubes. That secondary circuit is both a series and a parallel tuned circuit. Looking at the tuned circuit from the primary it is series. The emf is located in the secondary winding and the condenser is connected across the inductance. Looking at the circuit from the grid of the second tube the inductance and the capacity form a parallel tuned circuit. It is parallel or voltage resonance which is made use of in the second tube. If a generator were connected in place of the grid and filament connection the inductance and the capacity would be in parallel across the generator.

The Pump Parallel

In determining whether the connection is series or parallel it is well to regard the source of the emf as a pump and the impedances, or rather admittances, as pipe lines. The pump forces a certain amount of water through the system. If the same amount of water is forced through two or more sections of the pipe system (two or more impedances) they are connected in series. If the sections of the pipe system are so connected with respect to the pump that the water can divide, the sections are in parallel.

The electrical pump may consist of a primary battery, a storage battery, a magneto, a generator or dynamo, the secondary of a transformer, a microphone, a phonograph pick-up, a thermo-couple, the plate-filament circuit of a vacuum tube.

THIS SET USES AC TUBES

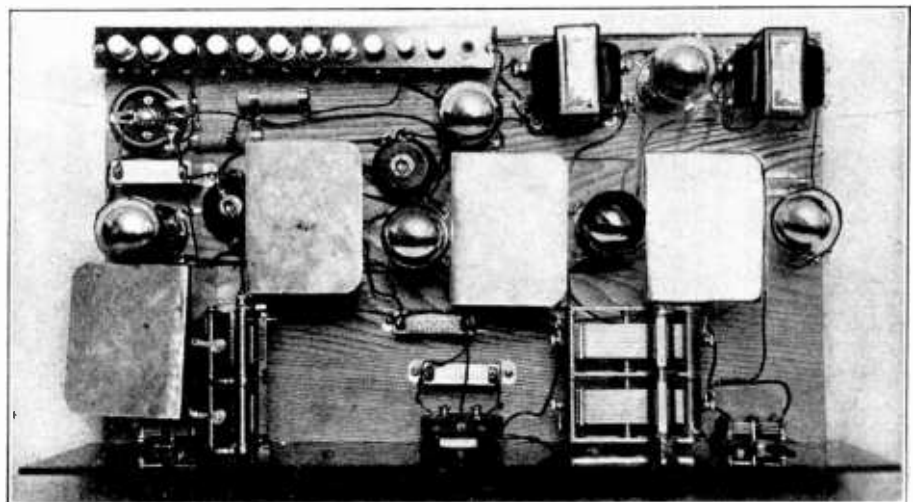

(Goodwin-Bruno)

AN INTERESTING view of the Puratone AC receiver described by Robert Frank Goodwin and Stuart S. Bruno in the September 10 issue of Radio World.

An Analysis of

By Brunsten

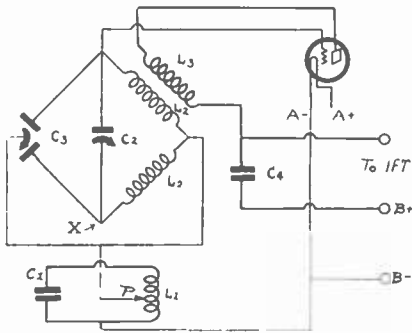

THIS SHOWS the basic features of the Strobodyne frequency changer as employed in the R. E. Lacault's American adaptation of Lucien Chretien's new receiver. The Wheatstone bridge principle is used to minimize the interaction between the two tuned circuits. (Fig. 1)

[The author, Brunsten Brunn, Super-Heterodyne expert, takes occasion to pay his respects to the Strobodyne, the circuit designed by Lucien Chretien, of Paris. This circuit was presented first to the American people by "Radio News" with the aid of Robert E. Lacault, who adapted M. Chretien's original article from the French.]

PART I

THE Strobodyne is a new circuit developed by Lucien Chretien of Paris, France, and belongs to the Super-Heterodyne family.

What is the significance of the term Strobodyne? This term is derived from the two Greek words "strobos," meaning a whirling, and "dynamis," meaning force. Thus the term means "a whirling force." Is there a force whirling about the new circuit to justify the name? Yes, there are two electro-motive forces whirling at the rate between 500,000 and 1,500,000 revolutions per second.

The term Strobodyne was directly derived from stroboscope, a well-known instrument used in physics and mechanics for observing regular periodic motions which are too fast to be observed with the unaided eye, for example, the operation of a gasoline engine running at the rate of 3,000 revolutions per minute.

As All Movie Fans Know

By means of the stroboscope the engine is illuminated intermittently at regular intervals which are so timed with respect to the speed of rotation of the machine that the effect is an apparent slowing down of the motion. The apparent slow motion may be in the same or in the opposite direction of rotation with respect to the engine. Or the machine may even appear to stand still. This phenomenon is familiar to all movie fans, for they have often observed that the apparent speed of the wheels of an automobile has little to do with the speed of the car itself. Sometimes the wheels turn backward when the car is moving forward, sometimes they stand still while the car is running, and sometimes they turn very slowly in the right direction when the car is running fast. The effect is due to the intermittent illumination of the screen.

In the stroboscope the apparent speed of rotation is the difference between the speed of rotation of the thing observed and the rate of intermittent illumination. This case is closely analogous to the beating of two alternating electro-motive forces, or currents, in a vacuum tube. When the two beat, a frequency is produced which is the difference between the two beating frequencies. If the two beating frequencies are the same, the beat frequency is zero, and this corresponds to the case of the automobile standing still.

Reality of Slowness in Radio

The slow motion observed in a stroboscope is only an optical illusion, although the frequency or speed of this motion is real. In the electrical case the slow motion resulting from two beating currents is real,

as well as its frequency. It is possible by means of a tuned circuit to pick out the beat frequency current and make use of it. That has been done in the new Strobodyne.

The new feature in the Strobodyne lies in the frequency changer. In the ordinary super-heterodyne the incoming signal is impressed on the grid circuit of a detector with the aid of a tuner. The grid voltage impressed on the grid in this manner is varied by super-imposing on it another high frequency voltage derived from the local oscillator. The detector produces a current of a frequency which is the difference between the incoming oscillations and the locally produced oscillations. Since the incoming signal was modulated with intelligence and the local oscillation is unmodulated, the beat frequency current is also modulated with the same intelligence as the incoming.

In the Strobodyne the incoming signal is impressed on the grid of the local oscillator; that is, the process of frequency changing is reversed.

To understand the operation of the frequency changer it is first necessary to consider the oscillator.

The Limiting Factors

The plate coil, or the feedback coil, impresses a certain voltage on the grid of the tube, provided that oscillations in the circuit have been started. The grid voltage thus impressed is amplified and the plate coil feeds back a still higher voltage. The voltage and current level in the oscillator would mount indefinitely if there were no limiting factors. These are the power available for dissipation and the characteristic of the tube. The tube cannot swing much negative without reducing the plate current to zero. It cannot swing very much positive without reaching the tube saturation limit. One might say that it is distortion in the tube which limits the voltage swing on the oscillator. With a certain size tickler coil and coupling, that is, with a given self-induced voltage on the grid, there is a certain amount of distortion in the output of the oscillator. If the grid voltage is increased by any other means the distortion is increased.

Thus if we impress a certain signal voltage on the grid of the oscillator in addition to the voltage impressed by the tickler coil, the distortion in the tube will be increased. The greater this distortion, within certain limits, the greater will be the beat frequency current between the signal and the local oscillation. And the greater the beat current for a given signal input the more sensi-

LIST OF PARTS

- C0, C1, C2—Three Hammarlund .00035 mfd. condensers.
- T0—One Hammarlund Auto Couple coil, specially tapped.
- L1, L4, L5—One Hammarlund Auto Couple coil, special.
- L2, L3—One Hammarlund Auto Couple coil, regular.
- IF—Four Radio Electric Lab. R.F. units (tuned).
- C4, C7—Five Radio Electric Lab. matched condensers.
- T1—One General Radio 285D audio frequency transformer.
- T2—One General Radio 285L audio frequency transformer.
- OF—One Muter Clarifier output filter.
- RFC—One General Radio 65 millihenry radio frequency choke.
- C3—One Cardwell compensator condenser, one rotor, two stators.
- R1, R2, R7—Three 20-ohm Carter rheostats.
- R6—One 400-ohm Carter potentiometer.
- C4abcd—Four .5 mfd. Dubilier by-pass condensers.
- C8—One .002 mfd. Dubilier condenser.
- Sw—One Carter filament switch.
- J1, J2—Two Carter jacks.
- R3—Four 1-A Amperites.
- R4—One No. 112 Amperite.
- C1a, Cn—Two Hammarlund balancing condensers.
- R5—One 100,000-ohm Electrad variable resistor.
- Three Hammarlund aluminum shields.
- Eight Benjamin UX sockets.
- Twelve X-L push type binding posts.
- Two National vernier dials.
- One 8x24x3/16 inch Micarta panel.
- One 12x25 1/4 x 1/4 inch Micarta sub-panel.
- Six doz. 6-32, 1 inch machine screws, with nuts.
- One and one half feet angle brass 1/2 x 1/2 inch.
- Two rolls of Belden rubber covered wire.
- Spaghetti.
- One Fritts cabinet to match panel.
- One Hammarlund brass shaft 1/4 inch diameter and 10 1/4 inch long.
- Seven CeCo—01A type vacuum tubes.
- One 112 type CeCo vacuum tube.

tive will the circuit be. If the oscillator tube did not distort it would be useless as a frequency changer. The amplitude of the resulting beat frequency cur-

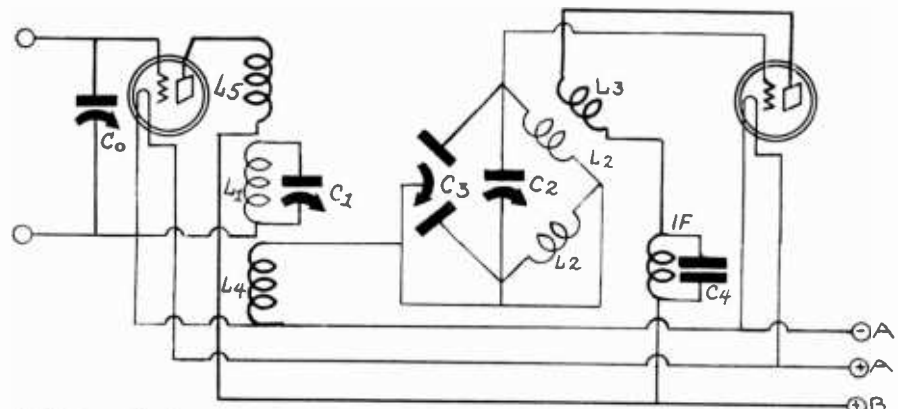

WHEN a radio frequency amplifier is put ahead of the Strobodyne frequency changer it may be done in this manner, as in Mr. Lacault's American version of the Strobodyne. Loose coupling between the oscillator and the input tuned circuit is assured by loose inductive coupling in addition to the bridge method. (Fig. 2).

the Strobodyne

Brunn

This makes the coupling very loose between the oscillator and the tuned circuit. If the top of the tuned circuit, or the return of P, were connected to the point marked X, the frequency of oscillation would be unduly affected by the tuned circuit. In fact, for certain settings of the tuned circuit the oscillator would not function at all.

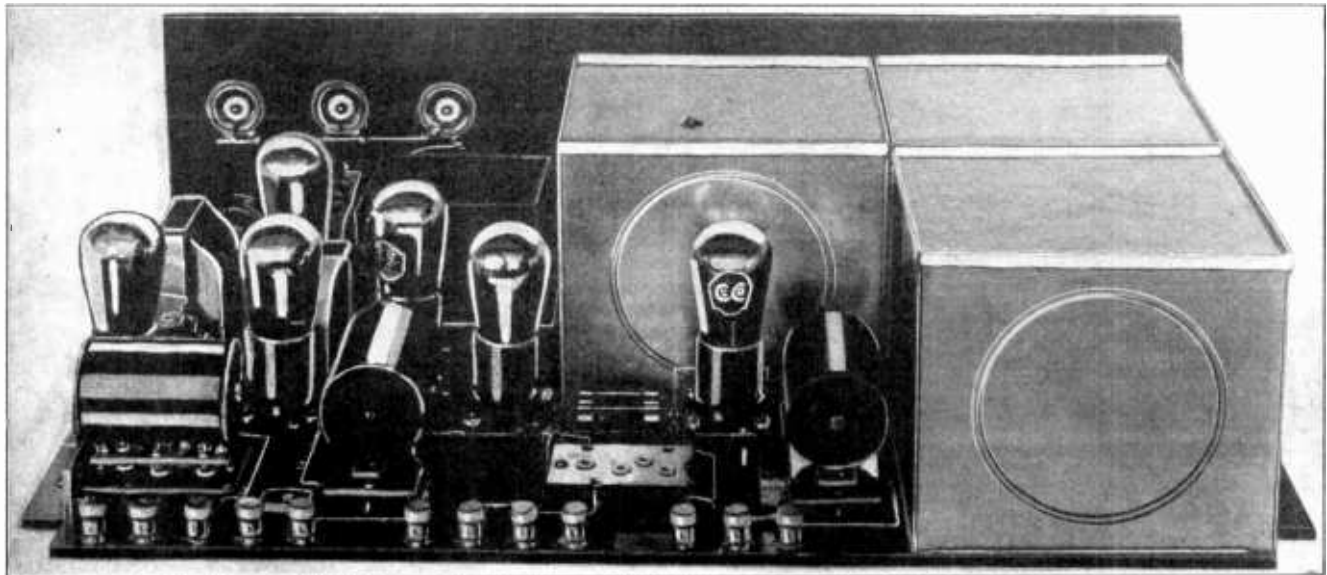

LAYOUT of parts as seen from the rear, with one coil removed.

rent, as is easily demonstrated, is proportional to the product of the amplitudes of the signal voltage impressed on the grid of the oscillator and of the voltage impressed on the grid by the tickler. Since the amplitude of the oscillations is very large and as fairly high signal voltages can be impressed on the grid in addition, the Strobodyne circuit is exceptionally sensitive. Much greater distances can be covered with a circuit of this type than with any other for the same number of tubes. This is true for still another reason, and that is the same tube acts as frequency changer and oscillator, while in other circuits two separate tubes are employed for these functions.

The selectivity of the Strobodyne circuit can be made as great as that of any other type of Super-Heterodyne, but special arrangements must be made. Since the grid swings positive half of the cycle, and as the grid resistance of a tube is very low when the grid is positive, the tuned circuit is effectively short-circuited half of the time. One would expect the selectivity to

be greatly decreased; and the circuit in this respect measures up to expectations.

Coupling Device Aids Selectivity

But the selectivity in the Strobodyne is increased by a very simple device, one which does not decrease the volume appreciably. The coupling between the tuned circuit and the oscillator grid is loosened. This decreases the load on the tuned circuit and this in turn allows higher voltages to be built up across it at the resonant frequency.

The frequency changer circuit as used in the Strobodyne is shown in Fig. 1. L1C1 is the tuned circuit in which the signal voltage is induced by the pick-up loop or other antenna. One side of this tuned circuit is connected to the grounded side of the oscillator. The other side could be connected to the low voltage side of the oscillation circuit. But this would make the coupling too close and the selectivity too low. Hence a tap P is provided by means of which the low side of the oscillator circuit can be connected to a point on L1 just a few turns from the ground side.

It is necessary to loosen the coupling between the oscillator and the tuned circuit still further. This is accomplished by connecting the lead from P to the neutral point on the oscillating circuit, that is, to the mid-point of the coil or condenser. Now it is not possible to find accurately the mid-point of the coil L2, and the mid-point in the condenser is not available. This difficulty can be overcome by the use of a Wheatstone bridge arrangement.

First the mid-point on the oscillating coil L2 is found as nearly as possible. Then a small balancing condenser C3 is connected across the tuned circuit. This condenser is such that when it is turned the capacity in one half is increased and the capacity of the other is decreased. The rotor can be set in such a manner that there is no voltage across the mid-point of the oscillating coil L2 and the rotor.

[Part II, the conclusion of Brunsten Brunn's article on the Strobodyne, will be published next week, issue of September 24.]

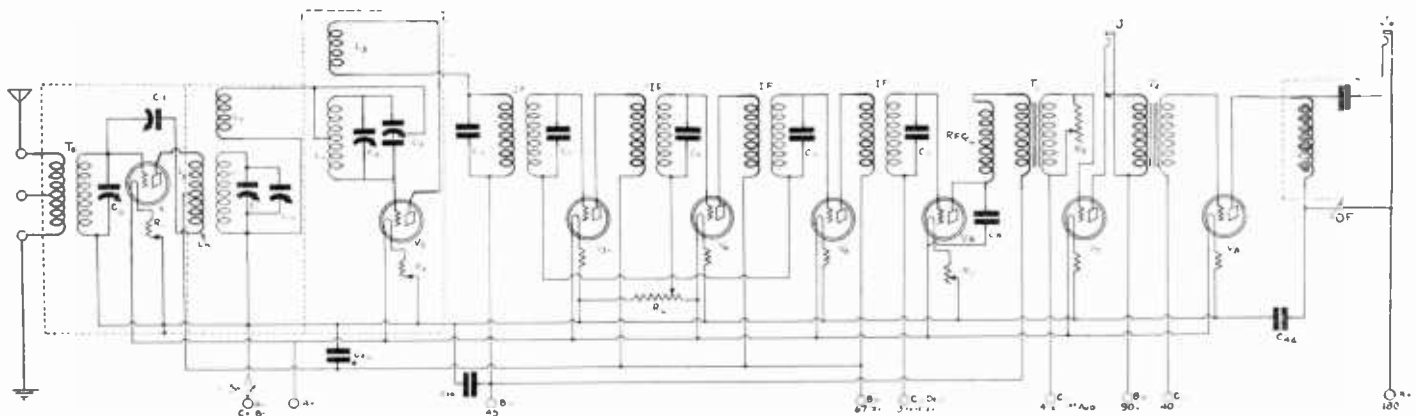

THIS is the complete circuit diagram of the Strobodyne receiver, as devised by Lucien Chretien and adapted for American parts by Robert E. Lacault. It employs eight tubes, V1 to V8. The novel feature of the receiver is the frequency changer V2 with its associated coils and condensers. V2 is the oscillator as well as the frequency changer. Independence between the oscillator and the radio frequency tuned circuits is obtained by loose inductive coupling between the pick-up coil L4 and the tuned circuit L1C1 and also by employing the balanced bridge method. Change from one type of tube to another is facilitated by the use of individual ballast resistors and rheostats in the filament circuits. Ample volume controls are located in all three frequency levels, thus preventing overloading in any part of the circuit. The main controls are R1, R5 and R6. An output filter OP is used to prevent damage to the loudspeaker windings. Though shown as a condenser-coil combination it may well be a Leslie F. Muter Clarifier. No filter is necessary when the loudspeaker is plugged into J1 because the first audio tube is not a power tube. (Fig. 3).

The Unified DIAMOND

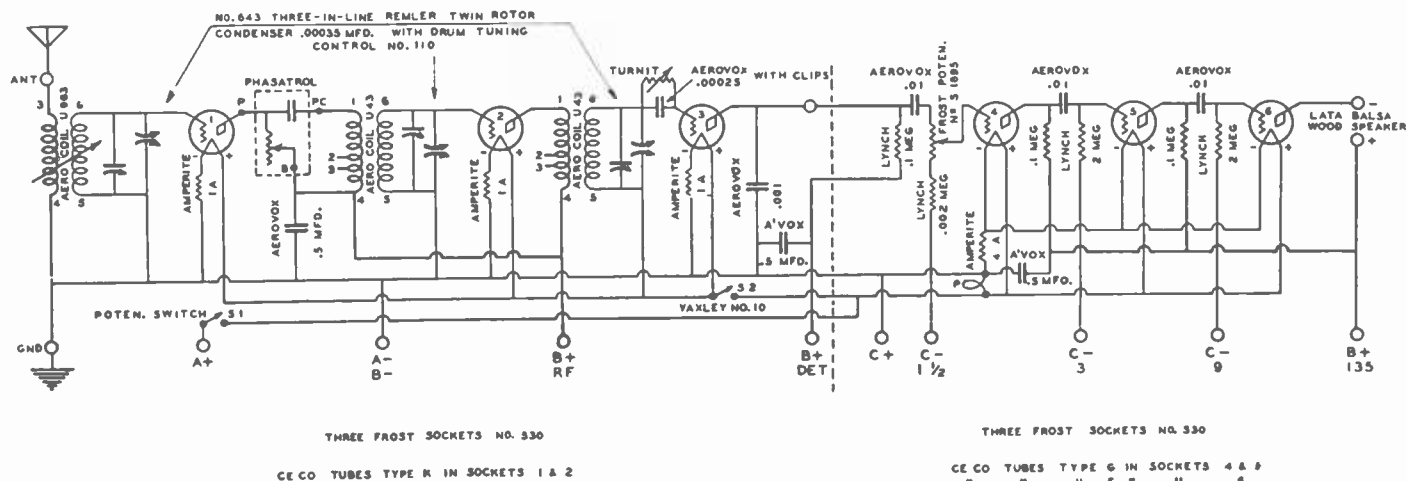

THE SCHEMATIC DIAGRAM of the wiring, with dotted line separating the Radio Frequency Fountain of the Unified Diamond from its Audio Frequency Basin. Note the filament wiring, which anticipates playing phonograph records through the Basin and the loudspeaker. If no phonograph pickup is to be used the filament wiring may be wisely followed nevertheless.

By the Laboratory Staff

A WEALTH of experimenting, engaged in by seven engineers in Radio World's laboratory, has resulted in the

LIST OF PARTS for the Radio Frequency Fountain *Organic Kit*

- One Remler three-in-line .00035 mfd. condenser, No. 643 (includes pilot lamp P).
- One Remler drum tuning control, No. 110.
- One Aero Universal antenna coil, U-963.
- Two Aero Universal wave trap unit coils, U-43.
- One Frost 500,000-ohm potentiometer, with switch, No. S1895 (switch is S1 in diagram).
- Three Frost sockets, No. 530.
- One Electrad Phasatrol.
- Three 1A Amperites.
- Three Amperite mountings.
- One Aerovox .001 mfd. moulded condenser, No. 1450.
- Two Aerovox .5 mfd. bypass condensers, No. 250.
- One Aerovox .00025 mfd. moulded grid condenser with clips, No. 1475.
- One Improved Turn-It variable grid leak.
- One Yaxley No. 10 switch (S2 in diagram).
- Two extra Remler knobs, one for Yaxley switch, the other for Frost potentiometer-switch.

Inorganic Kit

- One 2 $\frac{3}{4}$ x20x $\frac{3}{4}$ -inch Bakelite socket strip (note $\frac{1}{4}$ -inch thickness).
- One 7x21x3-16-inch Bakelite front panel.
- One pair of Bruno or Benjamin adjustable brackets.
- Six lengths of Acme flexible Celatsite.

Accessories

- Two CeCo type K tubes for sockets 1 and 2; one CeCo type H tube for socket 3.
- One 7x21-inch Corbett sloping cabinet, model TS, 10 inches deep, (genuine walnut or genuine mahogany; specify which)
- One Brach antenna kit.
- One Acme 5-wire cable.

design of a six-tube Diamond of the Air, and given the name of the Unified Diamond. This unification represents coordination of theory and practice and the choice of proper constants, and parts of impeccable manufacture, all of which when combined make a receiver of unusual beauty, simplicity and attractiveness.

The circuit is of the single tuning type. A three-in-line condenser, controlled by a drum, is used.

The volume control is unusual but not at all risky, since it has been given the severest kind of tests and has been found to approximate the ideal of a volume control for a receiver having resistance coupled audio.

The particular method of volume con-

trol has never before been presented, since it consists of a potentiometer which affords constant impedance while the variation in volume is obtained by the selection of the desired amount of voltage at the input of the first audio tube by rotating the potentiometer knob. This system at minimum setting would completely cut off the signal unless some minimum impedance were introduced, and this minimum after careful study has been selected as 2,000 ohms.

The Unified Diamond consists primarily of three co-ordinating units:

First, there is the Radio Frequency Fountain consisting of two stages of tuned radio frequency amplification and a tuned detector input.

Second, there is an Audio Frequency

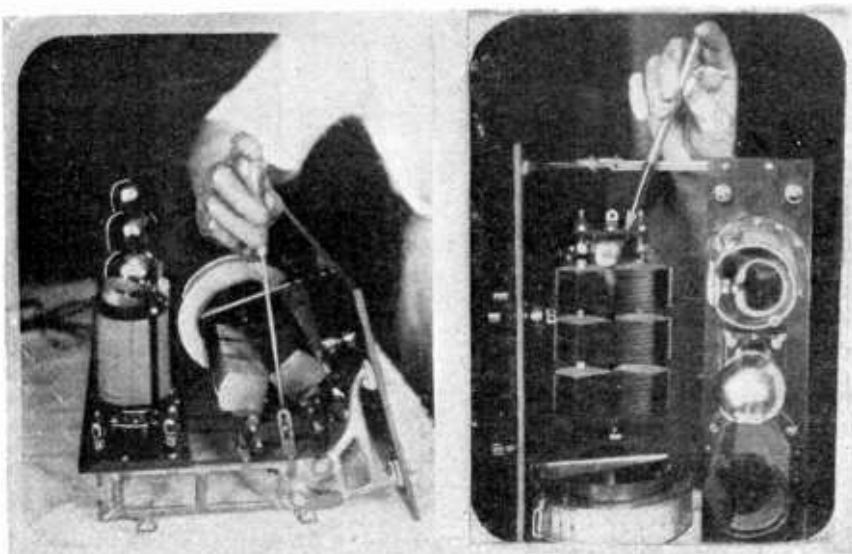

TO COUNTERACT the weight of the three-in-line condenser, by affording it support, an adjustable bracket is a factory-made part of the instrument. Hence, to put and keep the condenser frame in position, adjust this bracket so that the bottom of it is flush with cabinet base, and tighten down wood screw. The bracket then is screwed tightly to the condenser frame. Each of the three sections of the condenser is provided with a screw-action trimming condenser, to compensate for capacitive or inductive discrepancies. Once the set is adjusted for any given location these trimmers are touched left alone. They have mica rings as dielectric.

D A Synchronized Receiver of Six Tubes, Comprising the Radio Frequency Fountain and the Audio Frequency Basin—Power Geyser to Be Added

Basin, comprising three resistance coupled stages with constants chosen so that the audio basin will support high- μ tubes, thus affording increased volume.

Third, a Power Geyser, consisting of an extra stage of audio frequency amplification and embodying a plate power supply and 310 amplification.

In connection with the Radio Frequency Fountain a precision three-in-line condenser was selected and efficient coils used in conjunction with it. The tendency toward self-oscillation on miscellaneous frequencies was overcome by the introduction of the Phasatrol, the balancing or neutralizing device invented by John F. Rider.

The Radio Frequency Fountain is built for a 7 x 21-inch panel which may be sloping so as to fit into any sloping cabinet of that size. Therefore the brackets which secure the front panel to the socket strip are adjustable.

Front Panel View

On the front panel appear only these controls: The knob of the Remler three-in-line condenser; another for actuating the volume control and another for manipulating the separate switch. The volume control—of Frost manufacture—has a switch attached to it and this causes the audio channel tubes to light, but the radio tubes, including the detector, do not light unless the separate switch is turned on. This arrangement of filament wiring contemplates the use of a phonograph pick-up so that the beautiful records now being electrically recorded can be reproduced through the Unified Diamond Audio Basin and be emitted in all their true character by your radio loudspeaker.

To accomplish this requires the introduction of a phonograph pick-up to take the place of the sound box supplied with the phonograph. A Phonovox is connected to the detector tube socket and phonograph music is thus amplified at audio frequencies and delivered to the speaker.

The whole idea of the Unified Diamond was to develop a circuit with accessories that would not be inexpensive and yet would afford maximum comfort and pleasure in operation.

Nothing Tricky

No attempt was made to achieve any new circuit or to lead any constructor into fields that are hazardous because still experimental and unexplored. Conserva-

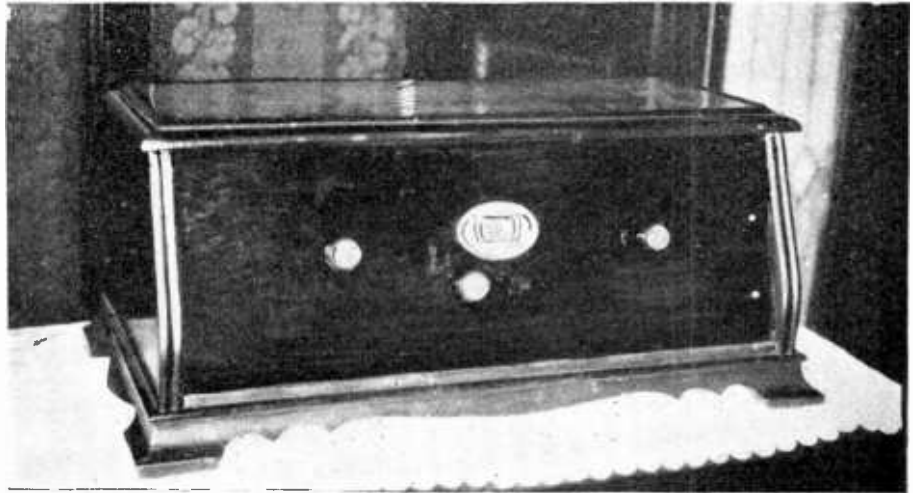

LOOKING at the front panel of the Unified Diamond, as it fits easily, with airy space and room to spare, in a 7x21x10-inch sloping cabinet of genuine walnut, one sees a receiver of exquisite decorative grace and soft simplicity. The tuning scale is illuminated by a pilot light supplied with the drum.

tism characterizes the receiver, while the net result is ample selectivity, tone quality which cannot be excelled by any of the known methods of audio amplification, and complete absence of squeals due to radio frequency oscillation, as well as absence of other extraneous noises due to faulty receiver design. In this connection emphasis is laid to the 0.5 mfd. Aerovox bypass condensers in the radio frequency channel, because these not only play a part in affording stability without sacrifice of amplification, but also, due to their large capacity, eliminate what are commonly called tube noises but which usually are due to the operating conditions of power supply sources that cause voltage fluctuations.

The tubes used in the Radio Frequency Fountain, each one of them, contribute full value, so that the amplification is built up from the very start. The amplification in the first tube is as high as can be reasonably expected in the support of stability, while the second RF tube represents a considerably greater gain per stage, and the detector functions also with admirable efficiency. Tube choice has as much to do with the gain as wise selection of coils and variable condensers. Hence with the new Aero Universal coils and the Remler three-in-

line condenser there are used two special radio frequency amplifying tubes, CeCo type K, and a special detector, CeCo type H, housed in Frost sockets. The grid leak is the new, improved Turn-it, moisture-proof and non-evaporating, and it is adjusted once, for maximum efficiency, and left thus.

The Unified Diamond was made what it is in the Radio Frequency Fountain only after considerable hesitancy about recommending a synchronously tuned first stage had been overcome by actual experiments in various locations, the trials being put into the hands of virtual novices, to make the tests the more valuable, although it is true that the instructions were complete. But as they were the same instructions that will be published in Radio World presently, the same uniformity of excellent results should prevail. The tests were made particularly for normally weak signal stations, and such stations were brought in with unusual strength, it mattering not whether their frequency was high or low in the broadcast spectrum.

(Part II next week)

LIST OF PARTS for the Audio Frequency Basin Organic Kit

- Three Lynch .1 meg. metallized resistors.
- Three Lynch 2 meg. metallized resistors.
- One Lynch .002 meg. (2,000 ohms) metallized resistor.
- Three Lynch double mountings.
- Three Frost sockets.
- Three Aerovox .01 mfd. moulded condensers, No. 1450.
- One Aerovox .5 mfd. bypass condenser, No. 250.
- Two Eby binding posts (speaker +, speaker -).

Inorganic Kit

- One 7x4x3-16-inch Bakelite base.
- Five feet for base.
- Six lengths of Acme flexible Celatsite.

Accessories

- Two CeCo type G tubes for sockets 4 and 5; one CeCo type F for socket 6.
- One Lata Balsa Wood Reproducer.
- One Pacent Phonovox.

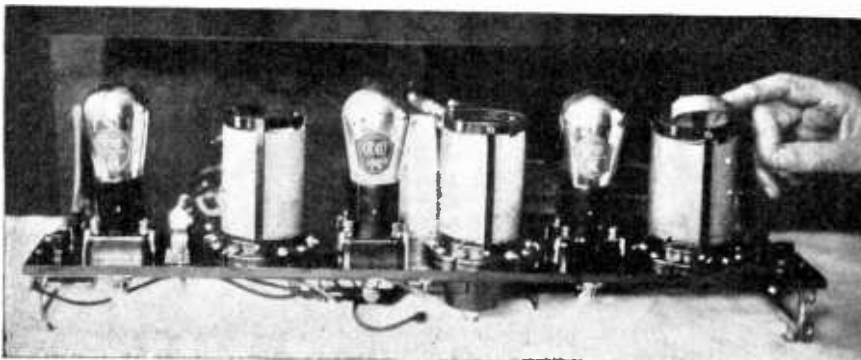

A NEAT ARRAY indeed, and denoting likewise the electrical efficiency that the entire Unified Diamond affords, is presented to the eye as the rear of the Radio Frequency Fountain is brought up. Here are coils in line, without troublesome interaction. No attempt has been made to crowd an audio channel into the cabinet space, but all due respects are paid first to RF before the audio considerations are introduced. Note that the antenna primary is adjustable.

We ~

Me and My Scientific Shadow

I

Am the
Experimental
Part of
My Nature

My
SHADOW

Is the
Theoretical,
Poetic
Inspiration

By H. B. Herman

LINDBERGH had his plane as his companion to constitute the famous team of "We" and it was always working with him, but I have something different to contend with and it is my Scientific Shadow. "We"—my Shadow and I—are constantly at odds. I am the experimental part of the team, while my *Shadow* is the mathematical, physical and even metaphysical component.

In my work as a radio engineer I am torn between the conflict of scientific ambition and experimental fruition. The things I hope to do—the coil I hope to make lossless, the resistor I hope to make imperishable, the capacity I hope to make infinite—all are the dreams that my Shadow inspires. But my slide rule holds me down with my feet to earth.

Which Is It?

At first blush my Slide Rule seems to be part of the Scientific member of the team but really it is with the mechanical member, because the Slide Rule is merely the physical means for quickly computing the experimental fact, the accurate quantity, the certain but unascertained entity, and has no place as an inspirer of dreams. It leads to more sad awakenings than any other instrument in my radio laboratory.

My Shadow looms large and ominous because it is the hopeful idealistic side of my radio nature, leading me to strive for circuits that surpass all others in their ability to pierce a barrage of stations nearby to penetrate the remotely distant program transmitter. It is my Shadow that gives me some measure of faith in the possibility perhaps of picking up signals from Mars, while my Slide Rule and its adjuncts of field intensity coil meters and dissipation laws, bind my creulity with fetters that even the stoutest black enlargement of my shadowy nature can not overcome.

Shadow Is Poetic

It is the Shadow that is the poet's side of We. It is the Slide Rule that is the mechanical side. While the university of the air gives opportunity for the exercise of all, both poetic aspirations and prosaic culminations, I am neither on the one side or the other, but enjoy a combination of both.

Some day I hope that the imaginative impulse that stirs me to mechanical and electrical achievements will carry me to the realization of the pluperfect and ultimate radio receiver, and then perhaps there will be for the first time a complete unity of identity between Me and my Scientific Shadow.



A Giant Cone On a Pedestal

By Leon L. Adelman

DUE to the great improvement in audio amplifiers a demand sprang up for large cones that would handle considerable volume with faithful reproduction and would facilitate the required emphasis to which low notes are especially entitled. Therefore, the 36-inch cone came into vogue and went through successive stages of refinement both as to the type and efficiency of the unit as well as the adaptability of the diaphragm or cone itself.

Two points interested engineers of the Powertone Electric Company above all others, and these were to provide a very sensitive and sturdy unit that would deliver much greater volume than usual, and incidentally to provide a suitable means for supporting and transporting a cone. While in many instances it is not only satisfactory but preferable to hang such a large cone on the wall, nevertheless many thousands of persons prefer to have a more secure and mobile support, hence the Powertone Pedestal Model Giant Cone was developed.

This cone is easily put together from a kit which consists principally of the following:

Two sheets of Fonotex paper, one of them decorated, the other plain.

The unit.

Two baffle rings with which to secure the rear circle of Fonotex paper at opening.

A pedestal for mounting the speaker.

A half moon wooden connecting link for joining the pedestal to the outer baffle ring.

A metal bracket for mounting the unit to the two holes in the extension loops of the baffle ring. (as shown in the rear view photograph).

The small metal cone or shield for the apex.

A thumb screw joint tightening against the stylus or extension rod of the unit.

A tube of cement.

The front sheet of Fonotex paper has

the design on it and this is marked with a V-shaped slot and the printed directions "Cut on Line."

How this cutting is done is shown on a photograph on this page. The circumference is likewise cut at the extreme rim of the design.

Now, using the cut piece as a template and laying it on top of the plain sheet of Fonotex, make a tracing with a pencil for use as a cutting guide. This tracing will consist of the circumference of the design sheet and V-shaped slot. With a small divider or compass describe a five-inch diameter or circle at the center and cut out in the same manner as was done previously, with the exception that the plain paper is cut one-eighth inch shorter around the circumference to facilitate cementing later. Also cut out the center-piece but do not throw away the five-inch circle of Fonotex as this will be used later as reinforcing for the front of the cone, that is the piece with the design on it.

The Slot Disappears

Now cement the two sheets together to form the cone. This requires that the V-shaped slot be made to disappear by drawing the two separate parts together and joining them. The five-inch diameter circle is likewise cut and is made into a cone. Let these pieces dry for at least fifteen minutes. When they are thoroughly dry, resume work.

Now take the front sheet and lay it out pointing down into the opening of a barrel or box and insert the apex fittings in the center. The one tin piece with the screw part is put on the outside. Cement the five-inch cone on the inside. Then the other tin piece goes on and next the nut. Fasten the apex therefore by screwing the nut down tight.

Now lay one of the metal rings inside, the ring that has no handle on it. This is the interior baffle ring. Place the plain or undecorated back cone the other way

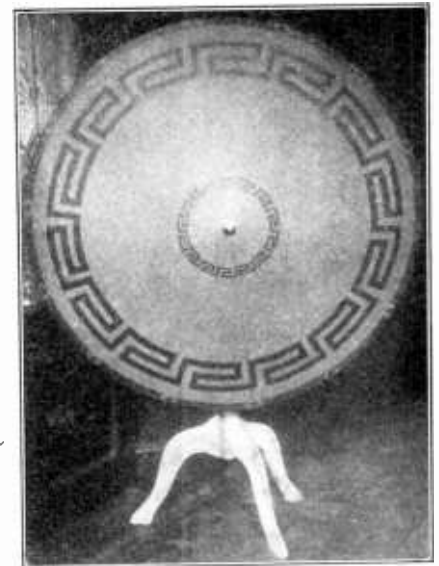

HERE'S how the completed speaker looks. It may be moved conveniently to any part of the house.

round on top of the front cone so that the edges meet with the exception of the one-eighth-inch leeway as previously explained. In other words, the front or decorated paper has a total diameter of one-quarter inch greater than that of the rear cone.

Nears Completion

Now place the other baffle ring on top so as to bear down on the paper, to keep the edges touching, and then run around the edge with the tube of cement and allow to dry for half an hour.

When this work is thoroughly dry fasten the two baffle rings together with the small screws and nuts, stretching the paper with each screw.

Now assemble the unit to the bracket. Place the unit inside of the cone so that the stylus or extension rod of the unit passes through the aperture of the little shield or metal cone previously referred to in the discussion of the fittings.

The stylus should move freely back and forth, because the thumb screw which is on the barrel must not be tightened down yet.

Now permanently mount the unit bracket on the rear baffle ring, the one with the handle on it. This work is done with two screws and two nuts and connection is made to the extension lips which are shown in the photograph pointing to each other on the inside diameter of the visible baffle ring.

Listen In

Care must be taken to put the unit on before the half moon is secured to the baffle ring. This may require holding the unit until the half moon is secured to the baffle ring. Two screws and nuts afford this security, the parts being provided with the holes.

The only remaining work is to insert the upright support of the pedestal into the aperture on the circumference of the half moon. When the proper tension point is found, by working the cone, tighten the thumb-nut securely, to the stylus.

Now you have a giant cone which will handle tremendous volume, give you dandy quality, and which has the very convenient attributes of portability and rigidity, with a handle to help you protect the cone against accident while it is being taken from one part of the house to another.

The pedestal model also may be used as a wall model, simply by removing the pedestal and fastening a narrow slab across the back, right onto the half moon. The slab should measure two or three inches less than the cone diameter. Put a screw-eye at either end of the slab and attach the picture wire.

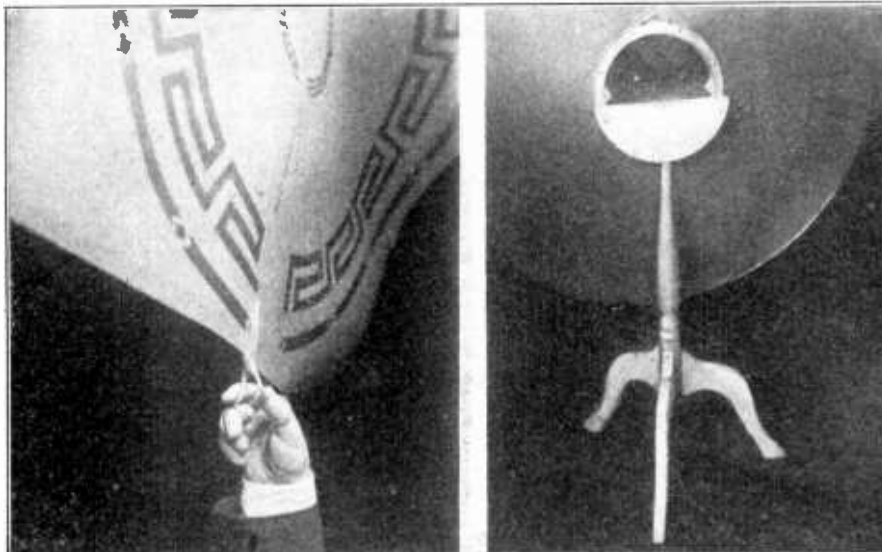

THE FONOTEX PAPER is in two pieces, one of them decorated, for the front, the other plain. In each case a V-shaped slot is cut, to facilitate making the paper conical. The rear view (at right) shows the plain paper, the outside baffle ring, the pedestal and the half-moon piece that joins pedestal to the baffle rings. The unit is to be mounted on brackets that fit in the baffle ring extensions.

The Wiring of The Victoreen

By Capt. Peter V. O'Rourke
Contributing Editor

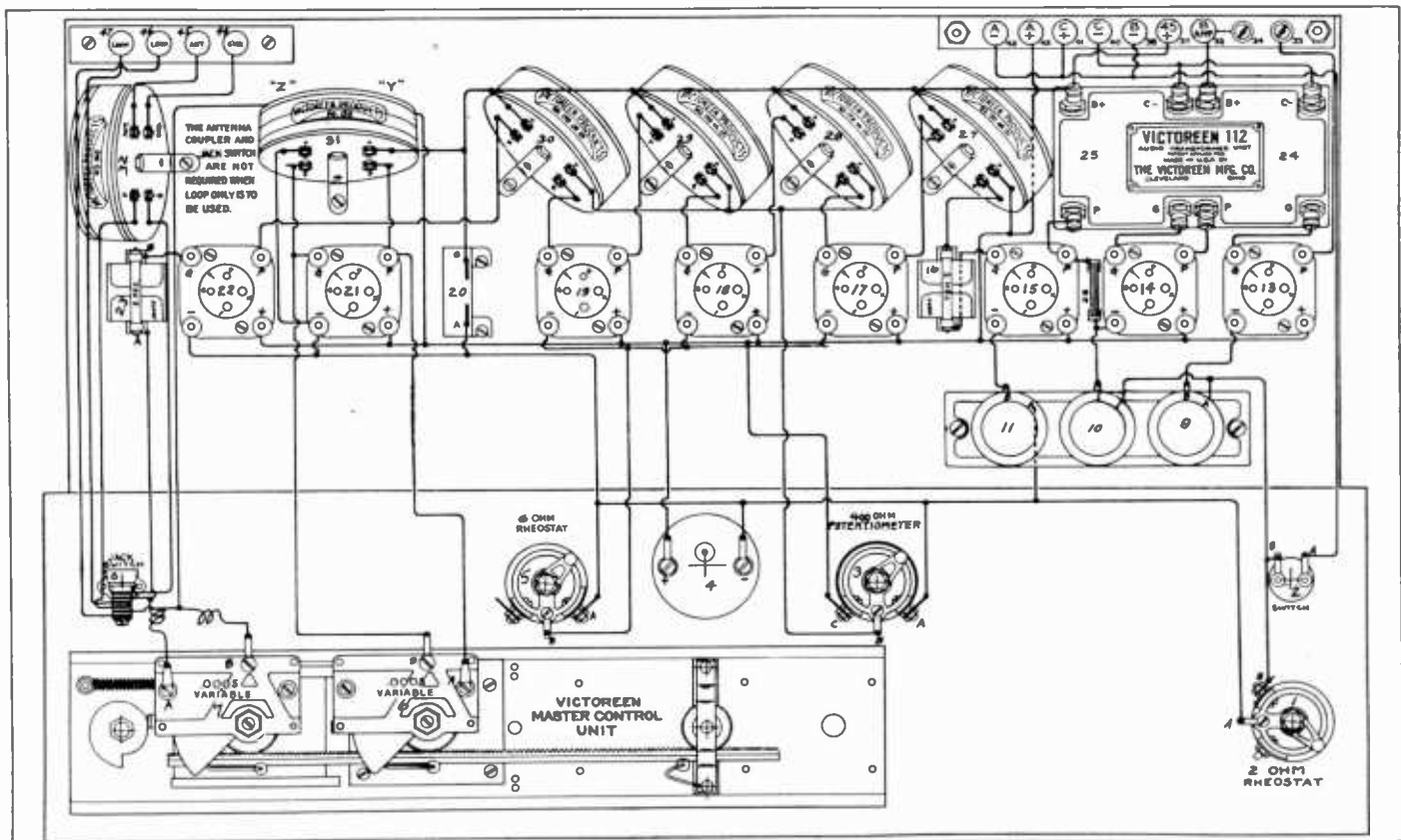

[Parts I and II of this four-part article on the 1928 Victoreen Universal were published in the issues of September 3 and 10. Part III is published this week. Part IV, the conclusion, will be printed next week, issue of September 24. The Victoreen long has been a favorite circuit, easy to build and to operate and noted for its tone and DX.]

If any distortion should occur in a Super-Heterodyne it is well to investigate the plate power supply. The resistance of the B battery or the impedance of the B battery eliminator very often causes mushiness in the signals, oscillations of an audible pitch or blasting on certain notes. This occurs more often in the better types of receivers than in the others. Hence if there is trouble of this kind in connection with the Victoreen Super-Heterodyne it is well to investigate the source of plate power. It can usually be remedied with a large condenser or two across the B terminals. The oscillation and the blasting are the same thing and they differ only in intensity.

The Eby sockets specified in the 1928 model Victoreen Universal Super-Heterodyne are primarily intended for mounting on Bakelite and similar insulating baseboard and for sub-baseboard wiring. In the description of the receiver in the Sept. 3 issue of RADIO WORLD a wooden baseboard was specified. This is all right, because the Eby socket is supplied with a drilling template which is so constructed that when the socket is to be

mounted on a wooden baseboard the template can be used as a miniature sub-panel. There is double advantage in this construction. The template used as a sub-panel for each socket keeps the socket off the wood and thus creates a break in any layer of dust which might gather on the baseboard. This will improve the insulation at all times. Again it facilitates wiring on the wooden baseboard and makes this as simple as if the sub-baseboard method of wiring were employed.

Some fans prefer pictorial wiring diagrams to schematic diagrams. The pictorial diagram is particularly desirable when a suggestion as to the actual layout of the parts is wanted. Such a diagram is shown in the accompanying cut. The Lignole front panel has been tipped forward and laid flat, on a plane with the baseboard. Thus connections between the parts on the two can be shown clearly. As will be observed, all leads are short and direct with an absolute minimum of crossing and reflexing. This insures stability of the circuit and freedom from oscillations.

The angle at which to place the Victoreen intermediate transformers can be obtained directly from the drawing. This angle, however, should only be a guide in laying the set out and should not be used as the final adjustment, unless that happens to be the very best arrangement. Small differences will occur which makes it advisable to change the angle somewhat. Note that all intermediate fre-

quency (IF) coils should be placed in the same manner.

The positions of the two Dubilier grid condensers (16) and (23) and the two Daven grid leaks are clearly shown in the diagram as is the position of the .002 mfd. Dubilier by-pass condenser (26). These numbers refer to those on the official blueprint supplied by the George W. Walker Co.

The Tobe 1 mfd. by-pass condenser, which is really part of the oscillating circuit, is so placed with respect to the oscillator socket and coils as to require the minimum length of leads. This confines the oscillations to the region of the set where they belong. Stray oscillations in the receiver are not conducive to quietness of operation.

The Victoreen No. 112 double audio transformer unit is very appropriately placed in the rear, right corner of the set, next to the binding post strip. The audio control unit, consisting of the three rheostats (9, 10, and 11), is placed in front of the tubes with which it is connected and also close to the master rheostat (1) and the Yaxley filament switch (2). This makes the leads very short.

The mechanical construction of the Victoreen master tuning unit can be seen clearly from the pictorial diagram. The pinion to which the Marco control dial is attached is located in the middle of the panel and the rack with which the pinion engages extends to the two condensers at the left

5,000 mfd. the Size of Your Fist!

By J. E. Anderson

Consulting Engineer; Contributing Editor;
Associate, Institute of Radio Engineers

CONDENSERS are used profusely in modern radio receivers and auxiliary apparatus. The demand is always for larger and larger condensers and for higher and higher breakdown voltages. Many circuits and accessory apparatus have failed to perform in accordance with expectations because the condensers used were not large enough or because their breakdown voltages were not high enough. Condensers are both expensive and bulky and therefore units not suited to the purpose have been used, but it has been false economy.

This situation has led to the investigation of the electrolytic condenser as a substitute for some of the more common forms of condensers where exceedingly large capacity is required. There are many reasons why electrolytic condensers are attractive. They are very inexpensive to make; they can be obtained in enormous capacities in relatively small space; they are self-healing after breakdown. Experiments with them have proved that they can be substituted for solid dielectric condensers in a great many cases with excellent results.

We shall point out some of the possible applications of the electrolytic condenser, but before proceeding it is well to tell what such a condenser is.

How They're Made

An electrolytic condenser is only an electrolytic rectifier used as a condenser. One common form of it consists of a piece of lead and a sheet of aluminum immersed in a saturated solution of ammonium phosphate or other suitable electrolyte. The aluminum electrode is positive and the lead is negative. Many different salts solutions can be used for the electrolyte and many different metals can be used for the negative electrode, but there are only a few metals which can be used as the positive electrode. Of these aluminum is the only common metal.

If a piece of lead and a sheet of aluminum are immersed in a strong solution of ammonium phosphate and insulated from each other, except for the solution, we have a potential electrolytic condenser. To make a condenser out of the cell it is necessary to "form" it. The forming process consists of building up a layer of non-conducting material on the aluminum plate, with the aid of an electric current. If the positive terminal of a source of electro-motive force is connected to the aluminum and the negative terminal is connected to the lead, a heavy current will flow, depending on the voltage of the emf and on the surface of the aluminum.

Current Decreases

At first this current is so heavy that it is necessary to insert a resistance in series with the circuit to keep the flow down to safe values. This resistance can be chosen on the assumption that the cell at first has no resistance at all, and that one ampere is desired. For example, if the emf is six volt storage battery, the resistance might be six ohms. The initial current through the condenser cell would then be one ampere.

But this current would not last very long. The non-conductive layer on the aluminum

builds up rapidly. After a few minutes the current would be down to a few milliamperes, if the cell has been properly constructed. The storage battery may be left connected to the cell for twenty-four hours. After that time the condenser will be formed and it can then be used as a large capacity condenser as long as the voltage across it does not exceed six volts.

The capacity of the electrolytic condenser depends on the forming voltage and on the effective area of the aluminum electrode. At a forming voltage of 10 volts the capacity per square inch of aluminum is about 30 microfarads.

Form on Direct Current

For a forming voltage of 400 volts the capacity is not more than .75 mfd. per square inch of aluminum surface.

It is best to form an electrolytic condenser on direct current, but it can also be formed on alternating current. It is also better to form it at a slow rate, that is, with a low value of initial current. With the low current it simply takes longer to form the condenser.

An electrolytic condenser will show some leakage after it has been formed. The amount depends on the surface of the aluminum and on the care that has been exercised in making the cell. If the aluminum contains other metals the leakage will be considerable, since particles of these impurities are not "film forming." Also if the surface of the aluminum has not been thoroughly cleaned before immersing, the leakage is likely to be high. Before immersing the electrodes in the electrolyte they should be thoroughly cleaned and freed from all grease.

Surface Increased

Rubbing the aluminum with a coarse emery cloth is beneficial in that it not only removes dirt from the surface but it also greatly increases the surface itself. If the cell has been well made the leakage should be less than a milliamper, but if poor aluminum has been used the leakage might amount to 20 milliamperes.

In many cases a little leakage is of no importance. In these cases electrolytic condensers can be substituted for mica and paper dielectric condensers.

One of the first applications that suggests itself is as a filter condenser in an A battery eliminator. In such a device it is not practical to use a large inductance coil to remove the ripple in the rectified current. It is necessary to use a very large condenser to level the current. It is obvious that a little leakage in the condenser is of no consequence. Since the voltage across the condenser will not exceed 6 volts, it is possible to form the condenser at a voltage below 10 volts and thus get a very large capacity in a comparatively small container.

In fact, it is possible to get a capacity of 5,000 mfd. in a quart jar.

Cost Is Low

The cost of such a condenser, including lead, aluminum, phosphate, distilled water, glass jar and terminals, is very moderate. Fig. 1 shows the connection of such a large condenser across the output of a rectifier, A1 indicating the aluminum plate and Pb the lead plate. Good results will be obtained without any choke coil at all, particularly if the rectifier is of the full wave type.



THIS electrolytic condenser was formed at 7.5 volts and its capacity is over 3000 mfd. It is used as a ripple remover in an A battery substitute.

If there is a small residual ripple in the output of the rectifier-filter shown in Fig. 1 a choke coil of about 1/2 henry can be inserted as shown in Fig. 2. This coil should be wound with very heavy wire on a core of ample dimensions. The output of this rectifier-filter will be quite free from ripple.

Another useful application of the electrolytic condenser of large capacity is shown in Fig. 3. It is as the filter condenser in the output of a power tube to protect the loudspeaker windings. For some unaccountable reason a condenser of 2 mfd. is almost universally recommended in this position.

And this is done after extreme precautions have been taken to preserve the quality of the signal in the amplifier.

Larger Than 10 Mfd. Advised

A 10 mfd. condenser could well be used in this position even if it had to be of the paper variety. But it is desirable to have even a larger condenser. There are several reasons for this. In the first place, the condenser is in series with the speaker and if the condenser is small it depresses the amplitude of the low notes.

This is aided by the fact that the choke coil across the condenser and speaker offers very little impedance to the low frequencies and permits them therefore to be by-passed.

This by-passing is greater the smaller the condenser is. But perhaps the most important reason for using a large condenser is the minimization of motorboating. This is most troublesome at low frequencies. If the condenser in series with the speaker were large and if the speaker were connected to minus A as in Fig. 3, the trouble would rarely occur, particularly if an inductance of 100 henrys were used in the choke coil.

It is obvious that an electrolytic condenser can be used in series with the speaker; and as this can be made as large as is required, all troubles due to stopping of the low notes can be eliminated with it. The condenser used for this purpose must be formed at a voltage equal to that applied

(Continued on page 28)

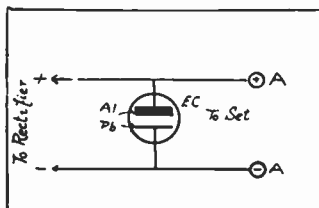

FIG. 1

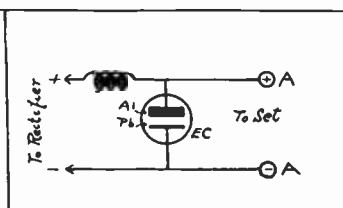

FIG. 2

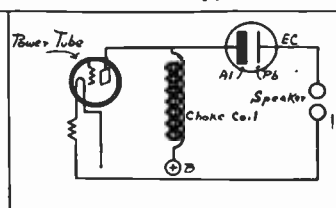

FIG. 3

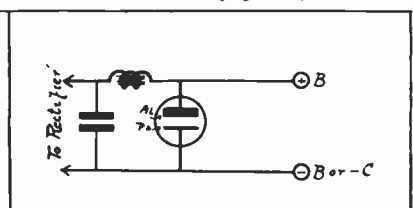

FIG. 4

THE author's conception of the ideal radio receiver is one that will operate without trouble, give almost perfect quality reproduction, bring in distant stations without trouble, and be easy to tune.

On the score of convenience the series-connection filament system may be used and ABC elimination accomplished.

A practical method of operating your receiver from AC is to use the new 350 mil Raytheon rectifier tube with the proper filter system and resistance network and wiring the filaments of the tubes, in the receiver, in series. The Ward Leonard resistance bank, 507-62, is standard for this.

While a little more expense and labor are involved, the final results make these worth while. The initial cost may be high, but in the long run this type of receiver will be the cheapest.

The correct biasing of all the tubes in the receiver and the steady unfluctuating current supply for the filament, plates and grids of the tubes, the correctly designed RF and AF amplifier, all assist to obtain the quality reproduction. When you tune in a station the tone is different than that emitting from nearly all other sets you have heard. The sounds are more natural.

DX Is Obtained, Too

Distant reception is also another feature of the set. This is made possible by the correctly designed radio frequency amplifier and the efficient method used to suppress oscillation and control regeneration. Also, it is the positive method incorporated to insure resonance of all tuned circuits.

The installation is built in two sections. One is the receiver portion while the other is the power supply for the receiver. These are built so that the receiver can be placed into a regular 7 x 21-inch cabinet and the power supply can be placed underneath a table top, or in a console compartment.

Three tuned stages of radio frequency amplification, tuned detector and two stages of audio amplification are used.

Each of the pairs of radio amplification is tuned with a double condenser. To make up for an unbalanced condition, due to additional capacity of tubes and wires, a compensating condenser is used across both tandem condensers.

The compensating condensers consist of two stators and one rotor. The rotor is connected to ground, while each of the stators connects to one of the stators on the tandem condenser. This has proved good, for if both stages of RF are in resonance, the compensator is kept in a neutral position. But if one of the stages is off, the compensator is turned either to the right or left, depending on the stage that requires more capacity. The coils

Fun Dodging

As Reported By Two Engineers Who
Built a Series-Filament Circuit

By Robert Frank Goodwin and Stuart S. Brown

used are of the well-known binocular type. These can be placed close together and in a straight line, without any chance of strong interstage coupling, as the field is confined, which also obviates shielding.

Phasatrols Balance Set

Oscillation is very effectively controlled by the two Electrad Phasatrols and the 100,000-ohm variable resistance in the plate circuit of all the RF tubes. Since oscillation predominates in the first and second stages, the Phasatrols were placed there. By adjusting the Phasatrols and varying the variable resistance, oscillation was smoothly controlled and the maximum of allowable amplification obtained from each stage.

The grid bias is obtained from the drop across the Amperites placed in series with the negative end of the first and third RF tube filaments. You may notice that the second RF tube is not supplied with a grid bias. This is due to the fact that a tandem condenser is used to tune the first and second stages and it is only possible to place a bias on one of the tubes when one uses the particular sequence of series connection shown.

All the tubes are 01A, except in the last stage, where a 71 power tube is used. While the filaments of the first five tubes are wired in series. The filament of the power tube is supplied by the power transformer. This is 5 volts AC. The plate voltage applied to the first tube is about 135, the grid bias for this tube is obtained from the drop across the resistance placed in series with its filament. This is an 18-ohm fixed Carter resistance. This supplies about 6 volts of grid potential.

The power tube requires 180 volts for its plate and 40½ for its grid, in this receiver the grid bias is supplied direct from the power supply.

Parts Layout

The layout of the parts for the receiver and supply unit is shown in the photo-

LIST OF PARTS

for Receiver

C1, C2—Two De Jur double variable condensers .00035 mfd.

R1—One De Jur 2 meg. grid leak.

L1, 2, 3, 4—Four Benjamin Lekeless transformers.

Six Benjamin Sockets, non-microphonic.

A1—Two Amperites, No. 1A.

T1, T2—Two Amertran audio transformers, AF3, AF4.

A2—One Carter 20-ohm fixed resistance.

C6, C7—Two Dubilier 1 mfd. condensers 160 volt.

C16, C17, C18, C19, C20—Five Dubilier 1 mfd. condenser 160 volt.

C5—One Dubilier .00025 grid condenser.

T3—One Thordarson output transformer R76.

P—Two Electrad Phasatrols.

R2—One Centralab 0-100,000 Heavy Duty Variable Resistance.

R4—One .1 meg. De Jur resistor.

C3, C4—Two Davenport compensator condensers.

One Carter Jack, open circuit.

Two Kurz Kasch vernier dials.

Two Kurz Kasch 1½" knobs, ¼" shaft.

Ten X-L Binding Posts.

Two rolls Corwico Braidite wire.

One 7 x 21 Micarta panel, Bakelite.

LIST OF PARTS

For Power Unit

T4—One Acme power transformer, No. 2239.

L5, L6—Two Acme choke coils, No. 2455A.

C11, C12—One Dubilier condenser block, P.L. 440.

C10, 13, 14, 15—One Dubilier condenser Block, P.L. 441.

C8, C9—One Dubilier condenser block, P. L. 439.

BA—One Raytheon 350 Mil rectifier tube.

One Ward-Leonard Resistance, No. 507-59.

One Ward-Leonard Resistance, No. 507-62 (resistance bank).

Eleven X-L Push Posts.

One plug receptable.

One Baseboard, 12½ x 20.

M—One Readrite, 0-300 millimeter.

One Readrite, 0-300 voltmeter.

Two rolls Corwico Braidite Flexible wire.

One Benjamin socket.

Five Armor CF 501 tubes.

One Armor CF 571 Power tube.

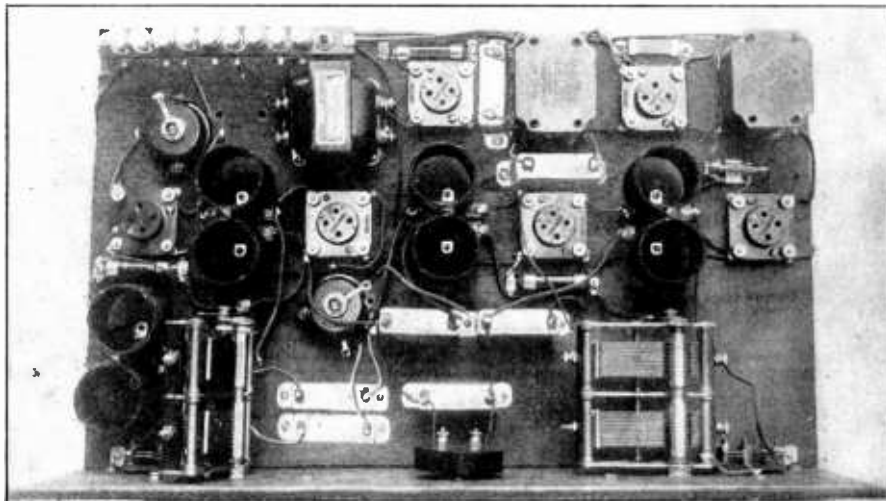

HERE'S the top view of the receiver.

graphs. The baseboard is 12 x 20 inches. The panel is 7 x 21 inches, preferably bakelite.

The 100,000-ohm heavy duty variable resistor is placed in the center of the panel. On each side of this the main tuning condensers are mounted. The one on the left being mounted in a vertical position while the one on the right is in a horizontal position.

In each lower corner of the panel, one of the compensator condensers (C 3) is mounted. The binding post strip should be raised 1 inch from the baseboard. This strip is about 8 inches long and contains

Trouble

a Carter midget jack, besides the X-L binding posts.

The receiver is wired with flexible wire. The constructor will find that if he follows the layout, the wiring will be very simple and will also notice that the grid leads are very short. He must remember that these should not run near any of the plate leads. Long battery wires going to the binding post strip can be placed along the back of the baseboard.

The baseboard for the supply unit measures 12 x 20 x 3/4 inches. This should be a piece of well seasoned wood, or asbestos board. This should be raised 3/4 inch from a surface by tacking a strip of wood along the edge.

The binding post strip is raised 1 1/2 inches from the baseboard, with brackets or long screws for support. The 20-ohm variable resistance shown on the extreme right-hand side should be mounted in a vertical position. This is to conserve space and allow for air circulation.

When wiring, all wires should be kept away from the resistance unit, since this unit gets hot.

Filament Adjustment

Since the output filter circuit contains only fixed resistances, some means must be used to control the filament current. Here we used the 20-ohm power rheostat in series with the primary winding of the power transformer. By varying this resistance, and also placing a 0-300 milliammeter in series with the negative end of the filaments, we can be sure of the fact that the tubes are receiving their proper filament current, which is 250 milliamperes. A voltmeter may be used across any one of the tube filaments for adjustment purposes, also. The reading should be 5 volts.

After the receiver and power portion are completed we are ready for testing. First, connect all the voltages of the power supply unit to their respective binding posts on the receiver. Then insert all the tubes. Turn on the house current. Then turn the power rheostat (Ward Leonard 507-59). This is the primary rheostat, R3. Vary it until the milliammeter in the filament circuit reads approximately 250, on the voltmeter 5 volts. Then check all the grid and plate terminals, being sure that they are receiving the proper voltages.

How to Balance

When preparing to balance the RF portion of the receiver, first turn the regeneration control (R 2) all the way to the right, and the Phasatrols completely to the left. Then tune in a strong high wave signal which should come in with tremendous volume and violent oscillation. To control this, adjust the resistance (R 2) back three-fourths of the way to the right, turn the Phasatrols to the left starting with the one in the plate circuit of the second tube and with the one in the plate circuit of the first tube. Turn these until oscillation has diminished and is controlled solely by (R 2).

This scheme of balancing must be repeated at several wavelengths and is not completed until oscillation is controlled by the regeneration control (R 2). At all times make sure that they are in resonance by manipulating the two compensator condensers.

DAY-FAN LICENSED

Day-Fan Electric Company, manufacturers of Day-Fan radio, are licensed under patents owned and controlled by the Radio Corporation of America.

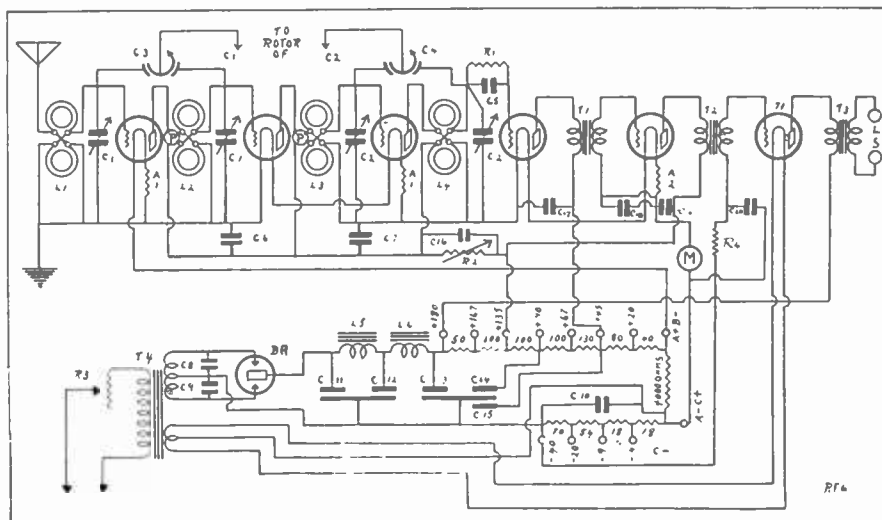

THE circuit network of a series-filament circuit, with a power tube in the last stage, its filament heated by AC. The power source is included.

Sun's Radio Effects Still Are a Mystery

Washington.

Experimental tests to establish a connection between radio atmospheric disturbances and solar activities have been conducted by the Department of the Navy in cooperation with the Bureau of Standards, according to L. W. Austin, of the latter Bureau. The experiments have led to no definite conclusion on the subject. Mr. Austin's statement:

"The suggestion that atmospheric disturbances might be due to a bombardment of the earth's atmosphere by electrified particles from the sun has been a subject of experimental test by the United States Navy and the Bureau of Standards.

"It was thought that there might be such a connection in the case of the type of atmospheric which sometimes produces simultaneous disturbances in the receiving apparatus at widely separated points, as in Honolulu or San Francisco, or even in Honolulu or San Francisco and Berlin.

"There seemed to be some evidence that these simultaneous disturbances took place when large sunspots were in the center of the sun's disk facing the earth. The observations have been made in San Francisco and in Washington and have been continued intermittently but without leading to any definite conclusion."

Talk to Belgium To Be \$20 a Minute

Telephone service between the United States and Belgium is expected to be inaugurated within a few weeks.

Since the establishment of telephone service between Great Britain and the United States, the Belgian Government has followed the development of trans-Atlantic telephone service with great interest. An agreement has been concluded recently in the British telephone service which will allow telephone communication between Belgium and the United States over the British-

American lines. No announcement is made as to the cost of such service, but rates will probably be in the neighborhood of 500 Belgian francs per minute (about \$20) with a minimum of three minutes. Communications may be made from any point in Belgium, with Brussels, from where the message is carried to London over the Brussels-Ghent-La Panne-London route and from London to the United States by trans-Atlantic wireless telephone.

Extensive plans are being laid.

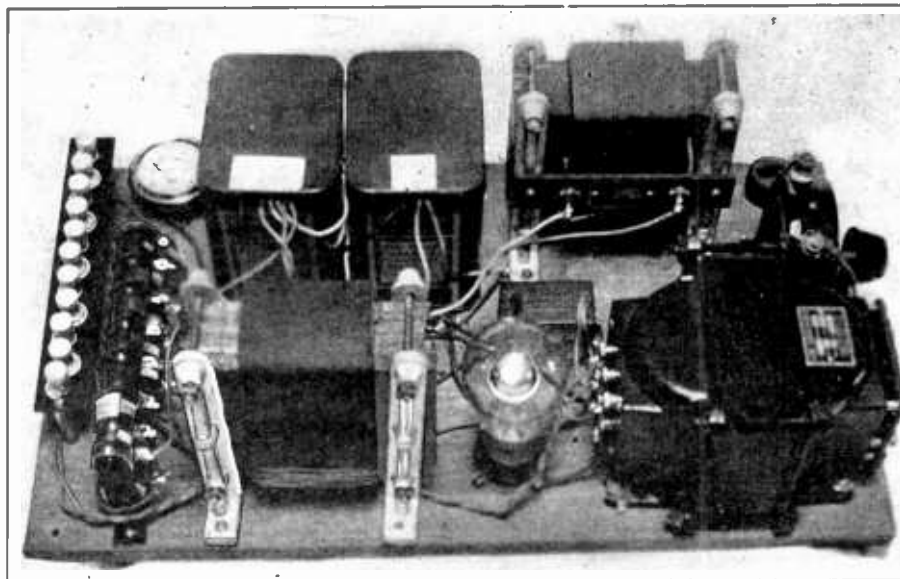

THE POWER UNIT the two engineers used.

A SUPPLY SOURCE FOR PORTABLE

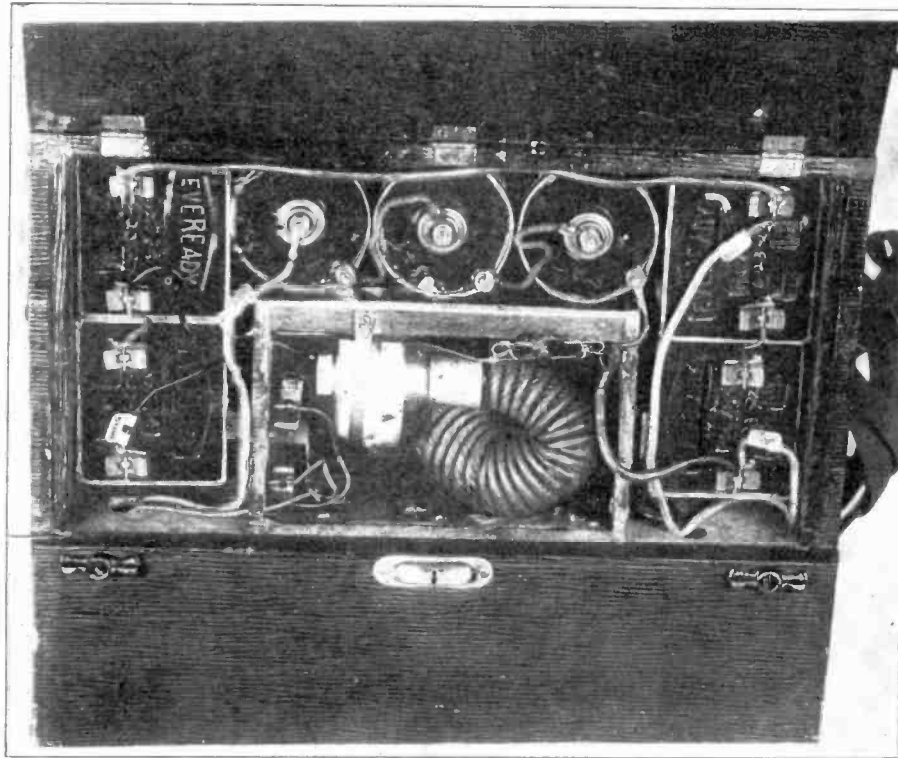

A BACK VIEW of a compact portable Super-Heterodyne designed and built by Robert S. Alter of Cincinnati, Ohio. On top are three No. 6 dry cells which furnish the filament current. At right and left are four 22½-volt dry cell batteries to furnish the plate power. In the small compartment below are the loudspeaker unit and part of the curved, flexible horn. At the left of the unit in this compartment is also one of the grid batteries.

A LOW PASS FILTER

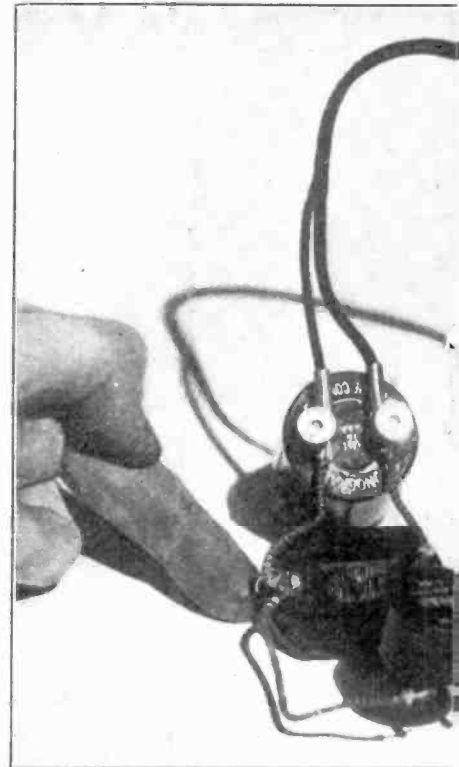

(Hayden)

THE PACENT PHONOVOX phonograph has been officially specified for the Unified Dian standard record can be played and then rep and loudspeaker, such as the Lata Balsa passages in the music of the record a trace loudspeaker. As a means of eliminating th consisting of a radio frequency choke and a b pick-up as shown in the photograph. The and the capacity of the condenser is .006 mf. is shown in Fig.

**How to Fly Is Taught
By Ace Over the Air**

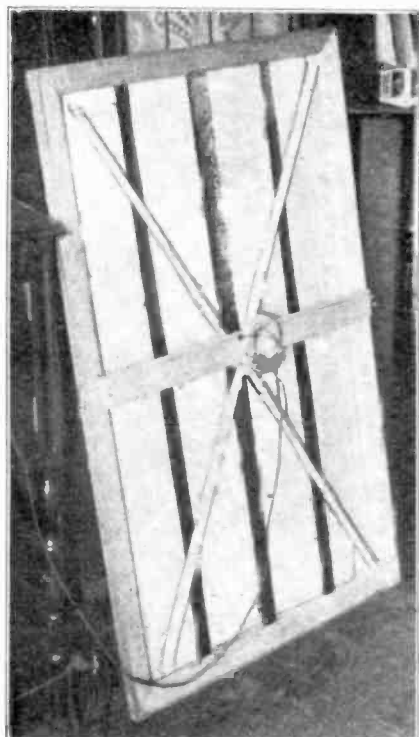

WHEN low notes are desired without harmonics a speaker like this Lata Balsa Wood Reproducer meets the conditions. Uniform response is obtained.

A broadcast of practical lessons in airplane flying through KOA, Denver, Colo., is on the air. Cloyd Clevenger, World War ace and now pilot at the Alexander Airport, gives them.

Clevenger has had great success as a test flyer and instructor in flying. There is much that a student pilot must learn before he takes his first flight, Clevenger says. It is this preliminary instruction he gives his radio flying class.

Lessons continue for 10 weeks, each Friday night from 8 to 8:15 p.m., mountain standard time.

Clevenger, assisted by Gene Lindberg, feature writer for the Denver "Evening News," will give the lessons in dialogue form to make their delivery more interesting.

CHICAGO SONG LEADER

Chicago has more aspiring young singers than any other city in America, if the applications to participate in the Atwater Kent Auditions can be taken as an indication. Already seventy-five have signified their intention to participate in the Chicago local contest sponsored by the Atwater Kent Foundation. Similar contests will be held throughout the country in every locality, but to date Chicago leads in the number of singers, men and women under twenty-five, who have expressed their intention to compete.

Extreme enthusiasm is, however, being shown throughout the entire country, according to the multitude of correspondence received at the Atwater-Kent offices.

**4th Element
New Trans**

The type RT-19-A transmitter has the distinction of being the first commercial radio transmitter to make use of the new four-element vacuum tubes.

Nearly all three-element tube radio frequency transmitting amplifier circuits require some form of neutralizing or balancing circuits to prevent the amplifiers from self-oscillation. This self-oscillation of radio frequency amplifiers is caused by feedback from the plate or output circuit to the grid or input circuit of the tube through the plate to grid capacity. When this condition occurs, all the desirable characteristics of radio frequency amplification are lost.

Neutralizing or balancing methods have been developed which prevent self-oscillation of the amplifiers, but these at best are critical in adjustment, and will not hold perfectly over a wide range of frequencies.

How Trick is Turned

Their use means additions of controls and complexity of operation which are very undesirable on commercial radio equipment.

In view of these facts the four-element transmitting tubes were designed. The successful method of stopping feedback is accomplished by the addition of a fourth element to the ordinary three-element vacuum tube, and of course, redesigning slightly to take care of effects introduced

ER FOR PICK-UP

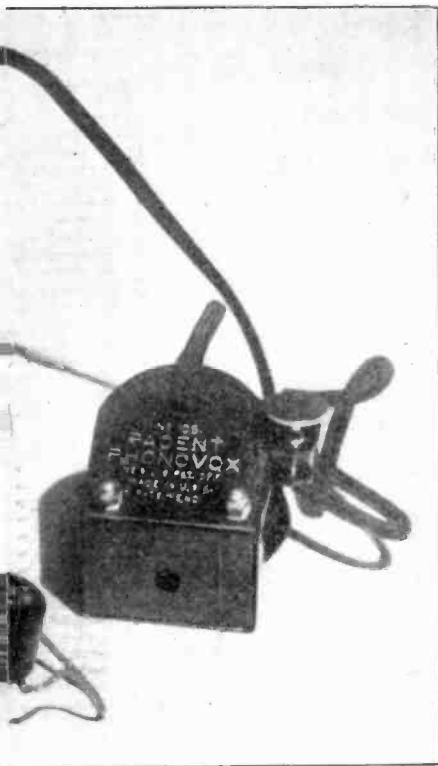

pick-up unit shown in this photograph has Wood Receiver. By means of this unit any reduced with a high-grade audio amplifier Wood Reproducer. On the more delicate of the needle scratch can be heard in the is slight disturbane a low-pass filter con-pass condenser can be connected to the inductance of the choke is 65 millihenrys 1. Another type of filter that can be used 565 on page 22.

**Balances
mitter Tube**

by the addition of the fourth element. This fourth element, or shielding grid, as it is called, is simply a fine meshed metal grid which is placed between the usual control grid and plate of the tube. The shield grid is maintained at a low radio frequency potential with respect to the operating grid and plate voltages with the result that the effective capacity between the control grid and plate is reduced to a very low value.

Feedback Impossible

This means that feedback is not possible through the tube, and it may be used as a radio frequency amplifier in the usual circuits without the necessity of neutralizing or balancing adjustments.

Modern radio transmitters are required to maintain very constant frequency in order to effect efficient communication. The master oscillator power amplifier type of circuit has been found best suited to this requirement since it is least effected by wide and rapid changes of antenna characteristics such as occur on board ships during heavy seas.

The RT-19-A transmitter makes use of one ZF-19 tube as master oscillator in an especially stable oscillating circuit, and one ZF-19 tube as power amplifier. The power amplifier is coupled to the antenna system through an antenna transformer which needs no adjustment over the entire frequency band, except a non-critical

CANARIES BROADCAST AND LISTEN IN

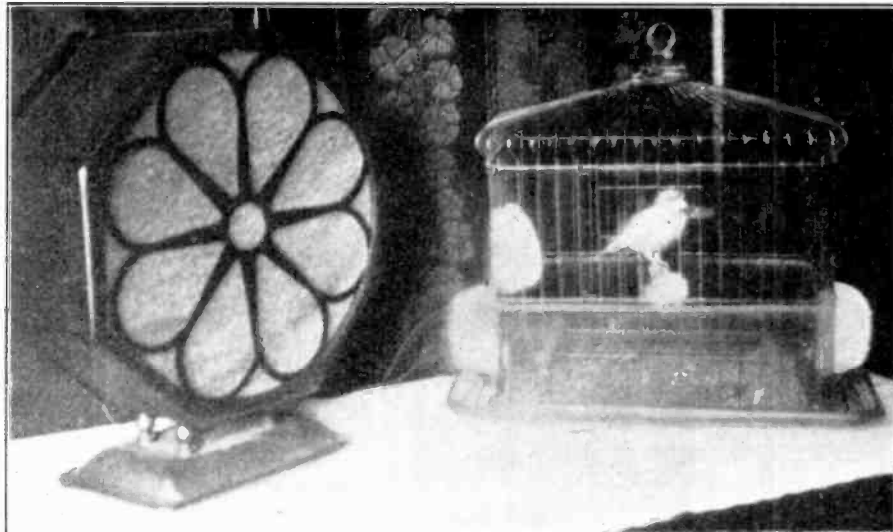

ONLY a bird in a cage, but happy nevertheless.

Sounds emerging from a loudspeaker affect canaries. They respond to the sounds, but all birds do not respond in the same way to the same sound, nor does the same bird respond the same way all the time to the same sound. Sometimes a bird will respond and start its own song when low notes are predominant. Sometimes a bird will respond with his own song when high notes are most prominent. And the bird does not always respond in a happy vein when the music is pleasant to the human ear.

A shrill whistle of the microphone variety will start the bird singing a merry song. At other times the bird will start singing when the human ear cannot hear anything, but when something is supposed to be playing. Apparently the bird hears and responds to notes above the audibility of the human ear, or he hears sounds so weak as to leave no impression on the human senses. Perhaps the sight of a loudspeaker will arouse pleasant

memories and make a reluctant bird sing. This is the moulting season and the bird does not seem so spry as at other times, often losing its song. A loudspeaker placed near him when pleasant music is playing helps the little musician to pass through the dismal period, sometimes making him sing weakly while moulting.

In many orchestras canaries take part in the music. The sounds from the various instruments encourage them to sing, and often they keep up a continuous warble. This adds greatly to the musical rendition. Canary birds listening to a loudspeaker reproduction of such music will quickly pick out the singing of the canary bird member of the orchestra and take up the song. The bird can hear his fellows singing above the much louder orchestral music. The instruments may drown the canary's warble to the human ear, but not to the ear of the listening bird.

adjustment for wide variation in antenna resistances.

The overall dimensions of the transmitter unit are approximately: width 22 inches, height 43 inches, and depth 25 inches. On account of its small size, the transmitter is particularly adapted to shipboard use where it may be placed in any small space available.

The transmitter has been designed with a minimum number of controls, and it may be easily operated by relatively inexperienced personnel. All that is necessary to put the transmitter into operation is to set the frequency by means of a calibration for the master oscillator, and then to resonate the antenna system to the working frequency. Actual operation of the RT-19-A transmitter under the conditions for which it was designed has shown that it meets these requirements in every respect.

RADIO STARTS BIBLIOGRAPHY

Radio is beginning its bibliography. As a new phase of our national life, it had to start from scratch. Nothing had been written about it, at least as radio is today. But books are being written.

Perhaps the most authoritative work on radio has just come from the pen of Judge Stephen B. Davis, who, as Assistant Secretary of Commerce under Herbert Hoover, had official charge of radio for the government. Judge Davis, recently resigned to accept an important legal position, has contributed "The Law of Radio Communication."

In a most comprehensive treatment of the subject. Judge Davis presents the his-

tory and development of radio from a non-technical side, present conditions in radio, the control of broadcast programs, conflicting rights in reception and transmission, federal jurisdiction and other phases of the subject.

SPEAKERS BANKED

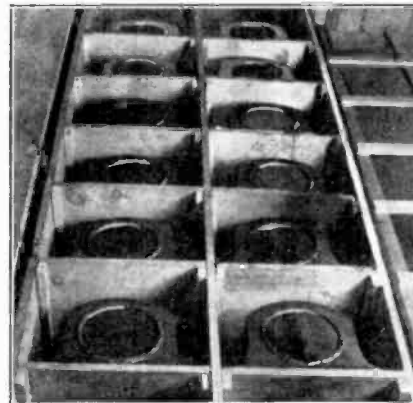

(Herbert Photos)

INTERIOR VIEW of the bank of loudspeakers mounted atop the building housing WODA, Paterson, N. J. The array is ten feet high and eight feet wide. It weighs one ton. Twelve small speakers are used to make up the entire unit, for broadcasting to passersby.

A THOUGHT FOR THE WEEK

NEW YORK'S big Fourth Annual Radio Show is here. In some respects this is an exhibition on the order of the fashion and industrial shows, with this difference: a group of stylists cannot get together and say that the public shall wear their radio sets at just such an angle during the coming year. The principle of radio does not permit the arbitrary rulings that obtain in the dress and suit business. Science may often be elusive, but at least principle rather than whims dictates the course of radio.

SIXTH YEAR

RADIO WORLD

The First and Only National Radio Weekly

Member, Radio Publishers Association

Radio World's Slogan: "A radio set for every home."

TELEPHONES: BRYANT 0558, 0559

PUBLISHED EVERY WEDNESDAY

(Dated Saturday of same week)

FROM PUBLICATION OFFICE

HENNESSY RADIO PUBLICATIONS CORPORATION

145 WEST 45th STREET, NEW YORK, N. Y.

(Just East of Broadway)

ROLAND BURKE HENNESSY, President

M. B. HENNESSY, Vice-President

HERMAN BERNARD, Secretary

European Representatives: The International News Co.

Breems Bldgs., Chancery Lane, London, Eng.

Paris, France: Brentano's, 8 Avenue de l'Opera

EDITOR, Roland Burke Hennessy

MANAGING EDITOR, Herman Bernard

TECHNICAL EDITOR, Lewis Winner

CONTRIBUTING EDITORS:

J. E. Anderson, Capt. Peter V. D'Rourke, and

James H. Carroll

SUBSCRIPTION RATES

Fifteen cents a copy. \$6.00 a year. \$3.00 for six months. \$1.50 for three months. Add \$1.00 a year extra for foreign postage. Canada, 50 cents.

Receipt by new subscribers of the first copy of RADIO WORLD mailed to them after sending in their order is automatic acknowledgment of their subscription order. Changes of address should be received at this office two weeks before date of publication. Always give old address; also state whether subscription is new or a renewal.

ADVERTISING RATES

General Advertising

1 Page, 7 1/4" x 11"	482 lines.....	\$300.00
1/2 Page, 7 1/4" x 5 1/2"	231 lines.....	150.00
1/2 Page, 8 1/2" D. C.	281 lines.....	150.00
1/2 Page, 4 1/2" D. C.	115 lines.....	75.00
1 Column, 2 1/2" x 11"	154 lines.....	100.00
1 Inch.....		10.00
Per Azote Line.....		.75

Time Discount

22 consecutive issues.....	20%
26 times consecutively or E. O. W. one year....	15%
4 consecutive issues.....	10%

WEEKLY, dated each Saturday, published Wednesday. Advertising forms close Tuesday, eleven days in advance of date of issue.

CLASSIFIED ADVERTISEMENTS

Ten cents per word. Minimum 10 words. Cash with order. Business Opportunities ten cents per word. \$1.00 minimum.

Entered as second-class matter March 23, 1922, at the Post Office at New York, N. Y., under the Act of March 3, 1879.

THE ORIGIN OF THE SINGLE CONTROL



The sheiks are responsible for the original demand for single-control sets. They could not understand why a man who needed only one arm to drive a car needed two to tune a set.

Maj. White to Describe Tunney-Dempsey Fight for Columbia

Changing his mind after his temporary retirement from the microphone, Major J. Andrew White, vice-president of the Columbia Broadcasting System, and pioneer sports announcer, will describe from Chicago the blow-by-blow radio picture of the Tunney-Dempsey battle the night of September 22.

He will broadcast from the ringside over WMAQ, Chicago. The Columbia chain's key station, WOR in New York, will pick it up and send to the other stations comprising the Columbia network.

This arrangement will make Major White's description of the fight available to practically the entire American radio audience east of the Rocky Mountains.

This will be the fourth time that Major White has had the opportunity to tell radio audiences the story of a championship fight in which Jack Dempsey was a contestant.

Major White's return to the microphone is interesting because it means that six years have elapsed since the Major conceived the idea that a prize-fight could be broadcast. From the Dempsey-Carpentier

bout at Boyle's Thirty Acres up to the present time he has not missed broadcasting a championship ring battle.

The following stations, sixteen in all, will do the broadcasting: WOR, Newark, N. J.; WEAM, Providence, R. I.; WNAC, Boston; WFBL, Syracuse, N. Y.; WMAK, Buffalo, N. Y.; WCAU, Philadelphia, Pa.; WJAS, Pittsburgh, Pa.; WADC, Akron, O.; WAIU, Columbus, O.; WKRC, Cincinnati, O.; WGHP, Detroit; WMAQ, Chicago; KMOX, St. Louis; WCAO, Baltimore; KOIL, Council Bluffs, Ia., and WOWO, Ft. Wayne, Ind.

At Last A Happy Home for! the Common Rotor!

How to Connect the Grid Return to One Point That Affords Two Simultaneous Bias Potentials, Both Correct!

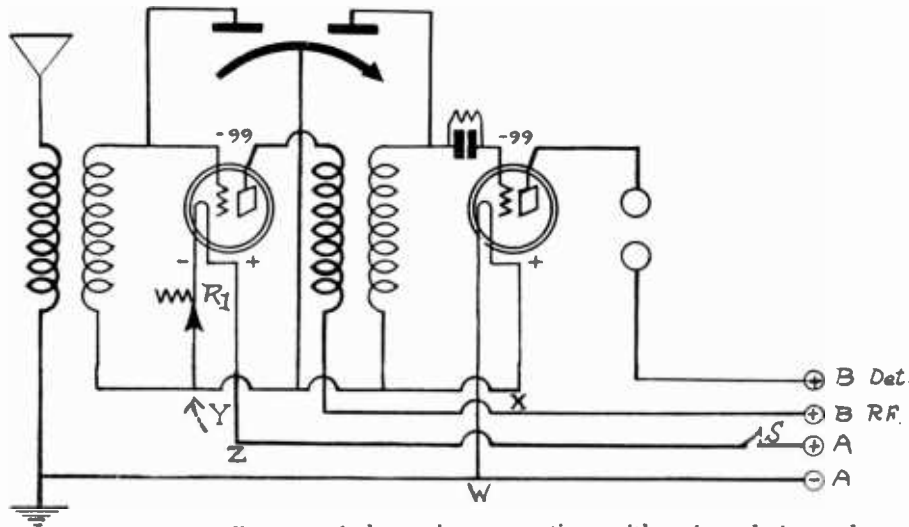

SCHEMATIC diagram of the series connection, with points designated.

By A. Irving Witz

SINCE the first tube of a tuned RF set is a radio frequency amplifier it requires a zero or a negative bias on the grid. If the second tube is the detector, as in the One Dial Witz, it requires a positive bias for most tubes. Now, when unified tuning is accomplished by means of a double section condenser in which the rotor plates of the two sections are metallically connected, the grid bias on the two tubes automatically becomes the same, unless special circuit arrangement is made. This bias may be either positive or negative. In the one case the detector works right but the amplifier tube does not. In the other case the radio frequency amplifier works right but the detector is inefficient.

One way of overcoming this difficulty is to connect the Turnit variable grid leak in the detector between the grid and the positive terminal of the filament instead of across the grid condenser. But connecting the grid leak from grid to filament puts it across the tuned circuit, and somewhat lowers the selectivity and the sensitivity of the receiver. This is not desirable. Furthermore, when the grid leak is connected in this manner the resistor clips on the grid condenser cannot be used and it is necessary to install a leak mounting. In many cases this is not a simple matter unless high potential leads are placed in unorthodox positions.

An Easy, Effective Solution

But there is a very simple way out, and it seems odd that it has not been used previously. This new method may be incorporated not only in the One Dial Witz but in other circuits where the same problem arises. It will be observed from the circuit diagram that two -99 type tubes are used, one for radio frequency amplifier and the other for the detector. The filaments of these tubes are connected in series and are then connected across a 6-volt filament battery. Since the tubes are in series the current drain from the battery is only 60 milliamperes, and each tube takes half of the voltage of the battery. That is, each tube gets its normal filament voltage of 3 volts. This connection works satisfactorily.

Now observe the order in which the filaments of the two tubes have been con-

nected across the 6-volt line. Starting with the negative terminal of the battery, at point W, we first come to the negative end of the filament of the detector tube and next reach the positive end of the filament of the detector (at about X), which is connected to the negative end of filament of the RF tube, at Y. Hence X and Y are the same lead. The positive end of the filament of the amplifier tube (point Z) is connected to the positive terminal of the filament through the switch S.

The negative end of the filament of the amplifier is at the same potential as the positive end of the filament of the detector.

If we connect the common rotor of the two sections of the tuning condenser (see arrow) to the line joining the two filaments and then connect the tuning coils in the usual manner, the grid potential of the amplifier will be at zero bias and that of the detector will be 3 volts positive bias, because bias is figured from the negative filament of each tube. Both tubes then will operate under correct

conditions. And the grid leak can be left across the grid condenser in the usual manner.

Thus by the simple means of connecting two -99 filaments in series it is possible to use a double section condenser for unified control without sacrificing selectivity and sensitivity occasioned by shunting the grid leak across the tuned circuit.

Suggested Volume Control

It is probably advisable to have a volume control in the radio frequency level to prevent overloading of the detector or loud signals, and also to prevent radio frequency oscillations at the higher settings of the tuning condenser. Hence a rheostat may be placed in the filament circuit of the radio frequency amplifier. Since the filaments of the two tubes in this circuit are connected in series, the rheostat will not only control the filament current in the radio frequency tube but also the current in the detector.

There are several places in which this rheostat can be inserted. The first tube will get a little negative bias, instead of zero bias, if we insert the rheostat in the negative leg of the filament of the RF tube. If any resistance at all is used there will be a little voltage drop. This will be a negative bias on the grid of the first tube. The rheostat in question is designated R1 in the drawing. From its position it will be observed that its insertion will not affect the common connection of the two rotors nor the bias on the detector tube.

The value of the resistance in R1 depends on how completely it is desired to throttle the volume in the radio frequency level. Suppose we wish to cut the filament current in half, that is, to 30 milliamperes. To do this the resistance in the rheostat should be equal to the sum of the resistances of the two filaments connected in series. Since the resistance of each filament is 50 ohms, the value of R1 should be 100 ohms. If the resistance is less than that the current will be more than 30 milliamperes when all the resistance is in. It is not necessary to reduce the filament current by more than 30 milliamperes because the volume decreases more rapidly than the filament current.

[The One Dial Witz was described in the issues of August 27 and September 3 and 10.]

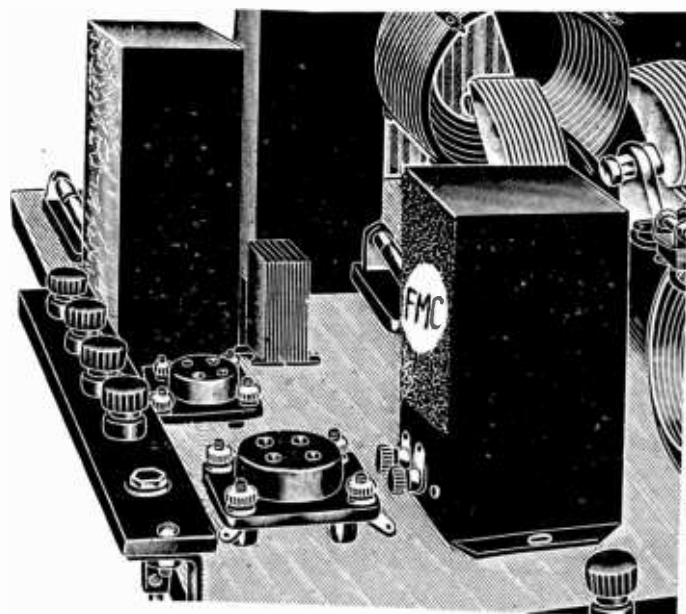

SERIES connection of the first two tubes of the One Dial Witz (sectional view of which is shown at left) results in a finely balanced receiver. The recommended audio channel is three stages of FMC double impedance coupling. The first two AF tubes may be type A, the last tube a 112.

LIST OF STATIONS

With wavelengths, frequencies, location and power, corrected to Sept. 7. Time sharers in parentheses.

Station	Kc	M	Watts
WAAD—Cincinnati, O.	1120	267.7	25
WAAF—Chicago, Ill. (WBBM, WJBT)	770	389.4	500
WAAM—Newark, N. J. (WGBS)	860	348.6	500
WAAT—Jersey City, S. J. (WGBB and WEVD)	1220	245.8	300
WAAW—Omaha, Neb. (6 to 7 only)	860	348.6	500
WABC—Richmond Hill, N. Y. (WBOQ)	920	325.9	2500
WABF—Pringleboro, Pa.	1460	205.4	250
WABI—Bangor, Me.	770	389.4	100
WABO—Rochester, N. Y. (WHEC)	1290	232.4	100
WABQ—Philadelphia, Pa.	1410	212.6	500
WABR—Toledo, O. (WTAL)	1070	21.6	50
WABW—Woeater, O.	1210	247.8	50
WABY—Philadelphia, Pa.	1210	247.8	50
WABZ—New Orleans, La.	1210	247.8	50
WADC—Akron, O.	1250	239.9	1000
WADF—Detroit, Mich. (WTHU)	1370	218.8	250
WAGM—Royal Oak, Mich.	1330	225.4	50
WAGS—Sarterville, Mass.	1390	215.7	5
WAIT—Taunton, Mass.	1400	214.2	10
WAIU—Columbus, O. (WEAO)	1060	282.8	5000
WALK—Bethayres, Pa. (Portable)	1490	201.6	50
WAMD—Minneapolis, Minn.	1330	225.4	500
WAPI—Auburn, Ala.; daytime only	610	491.5	1000
WARS—Brooklyn, N. Y. (WSDA, WBBC)	1320	227.1	500
WASH—Grand Rapids, Mich.	1170	256.3	250
WASN—Boston, Mass.	990	302.8	100
WATT—Boston, Mass.	1490	201.6	100
WBAA—West Lafayette, Ind. (WRM)	1100	272.6	500
WBAA—Harrisburgh, Pa. (WFPC)	1000	299.8	500
WBAL—Baltimore, Md.	1090	285.5	3000
WBAO—Decatur, Ill.	1120	267.7	100
WBAP—Fort Worth, Tex. (WFFA)	600	499.7	1500
WBAW—Nashville, Tenn.	1210	247.8	100
WBAX—Wilkes Barre, Pa. (WBRE)	1200	249.9	100
WBBC—Brooklyn, N. Y. (WARS, WSDA)	1320	227.1	500
WBBL—Richmond, Va.	1210	247.8	100
WBMM—Chicago, Ill. (WJBT, WAAF)	770	389.4	1000
WBPP—Potosky, Mich.	1250	239.9	100
WBRR—Rossville, N. Y. (WJBI and WEBJ)	1170	256.3	1000
WBWW—Norfolk, Va.	1270	236.1	50
WBYY—Charleston, S. C.	600	499.7	75
WBZZ—Chicago, Ill. (Portable)	1470	204.0	100
WBCN—Chicago, Ill. (WENR)	1040	283.3	250
WBES—Takoma Park, Md.	1010	296.9	100
WBET—Boston, Mass.	1240	241.8	500
WBKN—Brooklyn, N. Y. (WWRL, WIBI, WBMS)	1120	267.7	100
WBMM—Detroit, Michigan	1420	211.1	100
WBMS—Union City, N. J. (WBKN, WWRL, WIBI)	1120	267.7	100
WBNY—New York City, N. Y. (WKBO, WKBO)	1370	218.8	500
WBOQ—Richmond Hill, N. Y. (WABC)	920	325.9	500
WBRC—Birmingham, Ala.	1230	243.8	250
WBRE—Wilkes Barre, Pa. (WBAX)	1200	249.9	100
WBRL—Tilton, N. H.	1290	232.4	500
WBRS—Brooklyn, N. Y. (WCDA, WCGU, WRST)	1420	211.1	100
WBSS—Wellesley Hills, Mass. (WDWF)	780	384.4	100
WBT—Charlotte, N. C.	1160	258.5	500
WBZ—Springfield, Mass.	900	333.1	15000
WBZA—Boston, Mass.	900	333.1	500
WCAC—Mansfield, Conn. (WDRG)	560	535.4	500
WCAD—Canton, N. Y.	820	365.6	500
WCAE—Pittsburgh, Pa.	580	516.9	500
WCAH—Columbus, Ohio	560	535.4	250
WCAJ—Lincoln, Neb. (KMMJ)	790	379.5	500
WCAL—Northfield, Minn. (KFMX)	1270	236.1	500
WCAM—Camden, N. J.	1340	223.7	500
WCAP—Baltimore, Md. (WCBM)	780	384.4	100
WCAT—Rapid City, S. D.	1210	247.8	100
WCAU—Philadelphia, Pa.	890	336.9	500
WCAX—Burlington, Vermont	1180	254.1	100
WCAY—Carthage, Ill.	880	340.7	50
WCBA—Allentown, Pa. (WSAN)	1350	222.1	100
WCBD—Zion, Illinois (WLS)	870	344.6	5000
WCBE—New Orleans, La.	1320	227.1	5
WCBH—Oxford, Miss.	1240	241.8	100
WCBM—Baltimore, Md. (WCAO)	780	384.4	100
WCBP—Providence, R. I. (Portable)	1490	201.6	100
WCBZ—Springfield, Ill.	1430	209.7	250
WCCO—Minneapolis, Minn.	740	405.2	5000
WCDA—Brooklyn, N. Y. (WRST, WBRB, WCGU)	1420	211.1	500
WCFL—Chicago, Ill. (WLTS)	620	493.6	1500
WCGU—Coney Island, N. Y. (WCDA, WBRB, WRST)	1420	211.1	500
WCLO—Camp Lake, Wisc.	1320	227.1	100
WCLS—Joliet, Ill. (WKBB)	1390	215.7	150
WCMA—Culver, Ind.	1160	258.5	250
WCOA—Pensacola, Fla.	1200	249.9	500
WCOC—Columbus, Miss.	1300	230.6	250
WCOM—Manchester, N. H.	1260	238.0	100
WCOT—Olneyville, R. I.	1330	225.4	50
WCRD—Chicago, Ill. (WFKB & WPC)	1340	223.7	500
WCSH—Portland, Me.	830	361.2	500
WCSS—Springfield, Ohio	1170	256.3	500
WCWK—Fort Wayne, Ind. (WOWO)	1310	228.9	500
WCWS—Bridgeport, Conn. (Portable)	1490	201.6	100
WDAD—WALAC—Nashville, Tenn.	1330	225.4	1,000
WDAE—Tampa, Fla.	1120	267.7	500
WDAF—Kansas City, Mo.	810	370.2	1000
WDAG—Amarillo, Texas	1140	263.0	250
WDAH—El Paso, Texas	1280	234.2	100
WDAY—Fargo, N. Dak.	830	361.2	250
WDBJ—Roanoke, Va.	1300	230.6	250
WDBK—Cleveland, Ohio (WJAY)	1320	227.1	250
WDBO—Winston Park, Fla.	1250	239.9	500
WDBZ—Kingston, N. Y. (WOKO)	1390	215.7	50
WDEL—Wilmington, Del.	1130	265.3	100
WDGY—Minneapolis, Minn. (WRHM)	1150	260.7	500
WDOD—Chattanooga, Tenn.	1180	254.1	500
WDRC—New Haven, Conn. (WCAC)	1090	275.1	250

Station	Kc	M	Watts
WDWF—Cranston, R. I. (WBSO)	780	384.4	500
WDSI—			
WDWM—Newark, N. J. (WHAP, WMSG)	1270	236.1	500
WDZ—Tuscola, Ill. (Daytime only)	1080	277.6	100
WEAF—N. Y. City	610	491.5	50,000
WEAI—Ithaca, N. Y. (WOAX)	620	483.6	250
WEAM—North Plainfield, N. J.	1250	239.9	250
WEAN—Providence, R. I. (WNAC)	1130	265.3	500
WEAO—Columbus, O. (WAIU)	1060	282.8	750
WEAR—Cleveland, O. (WTAM)	750	399.8	1000
WEBC—Superior, Wisc.	1240	241.8	250
WEBE—Cambridge, Ohio	1210	247.8	10
WEBH—Chicago, Ill. (WJJD)	820	365.6	2000
WEBJ—New York, N. Y. (WJBI and WBBR)	1170	256.3	50
WEBQ—Harrisburgh, Ill.	1340	233.7	150
WEBR—Buffalo, N. Y.	1240	241.8	200
WEBW—Beloit, Wisc.	1160	258.5	500
WEDC—Chicago, Ill. (WGES)	1240	241.8	500
WEEI—Boston, Mass.	670	447.5	500
WEHS—Evanston, Ill.	1390	215.7	100
WEMC—Berrien Springs, Mich.	1260	232.0	1000
WENR—Chicago, Ill. (WBCN)	1040	283.3	500
WESP—Gloucester, Mass.	1010	296.9	100
WEVD—Woodhaven, N. Y. (WATT and WGBB)	1220	245.8	500
WEW—St. Louis, Mo.	850	352.7	1000
WEFA—Dallas, Texas (WBAP)	600	479.5	500
WFAM—St. Cloud, Minn.	1190	252	10
WFBC—Knoxville, Tenn.	1280	234.2	50
WFBE—Cincinnati, Ohio	1220	245.8	250
WFBG—Antonia, Pa.	1070	280.2	100
WFBJ—Collegeville, Minn.	1100	272.6	100
WFBK—Syracuse, N. Y.	1130	282.8	750
WFBM—Indianapolis, Ind.	1330	225.4	250
WFBP—Baltimore, Md.	1230	243.8	100
WFBZ—Galesburg, Ill. (WRAM)	1210	247.8	50
WFCI—Pawtucket, R. I. (WNBX)	1240	241.8	50
WFDL—Flint, Mich.	860	348.6	100
WFHH—Clearwater, Fla.	820	365.6	500
WFI—Philadelphia, Pa. (WLIT)	740	405.2	500
WFIW—Hopkinsville, Ky.	1220	245.8	500
WFKB—Chicago, Ill. (WCRW)	1340	233.7	500
WFKD—Philadelphia, Pa.	1460	205.4	100
WFLA—Boca Raton, Fla.	1410	212.6	1000
WGAL—Lancaster, Pa. (WKJC)	1190	252.0	15
WGBB—Freeport, N. Y. (WEVD and WAAT)	1220	245.8	400
WGBG—Freeport, N. Y. (WAAT, WSOB)	1220	245.8	400
WGBC—Memphis, Tenn.	1080	277.6	15
WGFB—Evansville, Ind.	1270	236.1	250
WGBI—Scranton, Pa. (WOAN)	1300	230.6	100
WGBS—Astoria, L. I., N. Y. (WAAM)	860	348.6	500
WGCP—Newark, N. J. (WNJ)	1070	280.2	500
WGCS—Chicago, Ill. (WEDC)	1240	241.8	500
WGHP—Mt. Clemens, Mich.	1230	243.8	1,500
WGL—New York, N. Y. (WODA)	1020	293.9	50
WGM—Jeannette, Pa.	1440	208.2	500
WGMU—New York, N. Y., Portable (WRMU)	1490	201.6	100
WGN—Chicago, Ill. (WLBB)	980	305.9	15000
WGR—Buffalo, N. Y.	990	302.8	750
WGST—Atlanta, Ga. (WMAZ)	1110	270.1	500
WGW—Milwaukee, Wisc.	1370	218.8	500
WGY—Schenectady, N. Y. (WHAZ)	790	378.5	3000
WHA—Madison, Wisc. (WLBB)	940	319.0	750
WHAD—Milwaukee, Wisc. (WTMJ)	1020	293.9	500
WHAM—Rochester, N. Y.	1080	277.6	500
WHAP—New York, N. Y. (WDWM, WMSG)	1270	236.1	1,000
WHAR—Atlantic City, N. J. (WPG)	1100	272.6	750
WHAS—Louisville, Ky.	650	461.3	500
WHAZ—Froy, N. Y. (WGY)	790	379.5	500
WHB—Kansas City, Mo. (WQQ)	890	336.9	500
WHBA—Oil City, Pa.	1150	267.7	10
WHBC—Canton, Ohio	1270	236.1	100
WHBD—Bellevue, Ohio	1350	222.1	100
WHBF—Rock Island, Ill.	1350	222.1	100
WHBL—Chicago, Ill. (Portable-Carrel)	1470	204.0	100
WHBM—Chicago, Ill. (Portable-Carrel)	1490	201.6	100
WHBN—St. Petersburg, Fla.	1010	296.9	10
WHBP—Johnstown, Pa.	1310	228.9	250
WHBQ—Memphis, Tenn.	1290	232.4	100
WHBU—Anderson, Ind.	1360	220.4	15
WHBW—Philadelphia, Pa. (WIAD)	1360	220.4	100
WHBY—West De Pere, Wisc.	1200	249.9	50
WHDI—Minneapolis, Minn. (WLB)	1220	245.8	500
WHDC—WABO—Rochester, N. Y.	1180	254.1	100
WHFC—Chicago, Ill.	1390	215.7	200
WHK—Cleveland, Ohio (WJAY)	1130	265.4	500
WHN—New York, N. Y. (WQAO)	760	394.5	500
WHO—Des Moines, Iowa	560	535.4	5000
WHPP—New York, N. Y.	1450	206.8	10
WHT—Chicago, Ill. (WIBO)	720	416.4	5000
WIAD—Philadelphia, Pa. (WHBW)	1360	220.4	50
WIAS—Burlington, Iowa	630	475.9	100
WIBA—Madison, Wisc.	1250	239.9	100
WIBG—Elkins Park, Pa. Sunday, day time only	680	440.9	50
WIBI—Flushing, N. Y. (WBKN, WWRL, WBMS)	1120	267.7	100
WIBJ—Chicago, Ill. (Portable-Carrel)	1490	201.6	100
WIBM—Chicago, Ill. (Portable-Carrel)	1490	201.6	100
WIBO—Chicago, Ill. (WHT)	720	416.4	500
WIBR—Steubenville, Ohio	1200	249.9	50
WIBS—Elizabeth, N. J. (WTRC, WLBB)	1470	202.6	150
WIBU—Polynette, Wisc.	1380	217.3	20
WIBW—Chicago, Ill. (Portable-Carrel)	1470	204.0	100
WIBX—Utica, N. Y.	1260	238.0	150
WIBZ—Montgomery, Ala.	1300	230.6	15
WICC—Bridgeport, Conn.	1400	214.2	250
WIL—St. Louis, Mo.	1160	258.5	250
WIOD—Miami Beach, Fla.	1210	247.8	1000
WIP—Philadelphia, Pa. (WOO)	590	508.2	500
WIAD—Waco, Texas	670	447.5	500
WIAG—Norfolk, Nebr.	1350	222.1	250
WIJK—Kokomo, Ind.	1280	234.2	500
WIJM—Cedar Rapids, Ia. (KWCR)	780	384.4	100
WIAR—Providence, R. I.	620	483.6	500
WIAS—Pittsburgh, Pa. (KQV)	1110	270.1	500
WIAX—Jacksonville, Fla.	890	336.9	1000
WIAY—Cleveland, Ohio (WHK)	1130	265.3	500

Station	Kc	M	Watts
WJAZ—Mt. Prospect, Ill. (WMBI)	1140	263.0	5000
WJBA—Joliet, Ill.	930	322.4	50
WJBB—St. Petersburg, Fla.	870	344.6	250
WJBC—LaSalle, Ill.	1320	227.1	100
WJBI—Red Bank, N. J. (WEBJ, WBBR)	1170	256.3	250
WJBK—Ypsilanti, Mich.	1360	220.4	15
WJBL—Decatur, Ill.	1410	212.6	250
WJBO—New Orleans, La.	1140	283.3	100
WJBR—Omro, Wisc.	1320	227.1	100
WJBT—Chicago, Ill. (WBBM, WAAF)	770	389.4	1000
WJBU—Lewisburg, Pa.	1400	214.2	100
WJBW—New Orleans, La.	1260	238.0	30
WJBY—Gadsden, Ala.	1280	234.2	50
WJCB—Chicago Heights, Ill.	1440	214.2	100
WJJD—Mooseheart, Ill. (WEBH)	820	365.6	1000
WJWP—Ashtabula, Ohio	1440	208.2	100
WJR—WCX—Pontiac, Mich.	680	440.9	4700
WJZ—Bound Brook, N. J.	660	454.3	3000
WKAF—Chicago, Wisc. (WTKM Milwaukee, Wisc.)			
WKAQ—San Juan, P. R.	880	340.7	500
WKAR—East Lansing, Mich. (WREO)	1300	230.6	1000
WKAV—Laconia, N. H.	1340	223.7	50
WKBB—Joliet, Ill. (WCLA)	1390	215.7	150
WKBC—Birmingham, Ala.	1370	218.8	10
WKBE—Webster, Mass.	1310	228.9	100
WKBF—Indianapolis, Ind.	1190	252.0	250
WKBG—Chicago, Ill. (Portable)	1490	201.6	100
WKBH—La Crosse, Wisc.	1360	220.4	500
WKBI—Chicago, Ill.	930	322.4	50
WKBL—Monroe, Mich.	1460	205.4	15
WKBM—Newburgh, N. Y.	1440	208.2	100
WKBN—Youngstown, O. (WMBW)	1400</		

Station	Kc	M	Watts	Station	Kc	M	Watts	Station	Kc	M	Watts
WNBO—Washington, Pa.	1420	211.1	15	KDYL—Salt Lake City, Utah	1160	258.5	100	KGDY—Shreveport, La.	1410	212.6	250
WNBQ—Rochester, N. Y.	1480	202.6	15	KELW—Portland, Calif. (KPPC)	1310	228.9	250	KGDY—Oldham, S. Dak.	1450	206.8	1
WNBW—Memphis, Tenn.	1310	228.9	20	KEX—Portland, Ore.	1250	239.9	2500	KGEF—Los Angeles, Calif.	1140	263.0	500
WNJ—Newark, N. J. (WGCP)	1070	256.3	1000	KFAB—Lincoln, Nebr. (5000 before 7 p. m.)	970	309.1	2000	KGEH—Eugene, Ore.	1490	201.6	50
WNOX—Knoxville, Tenn.	1130	265.3	1000	KFAD—Phoenix, Ariz.	1100	272.6	500	KGEG—Yuma, Colo.	1470	204.0	10
WNRC—Greensboro, N. C.	1340	223.7	500	KFAU—Boise, Idaho (4,000 watts daytime)	1050	285.5	2000	KGEO—El Centro, Calif.	1330	225.4	10
WNYC—New York City, N. Y.	570	526	500	KFBB—Havre, Mont.	1090	275.1	50	KGEO—Grand Island, Nebr.	1460	205.4	100
WOAI—San Antonio, Texas	990	302.8	2000	KFBG—San Diego, Calif.	1210	247.8	100	KGEU—Minneapolis, Minn.	1480	202.6	50
WOAN—Lawrenceburg, Tenn.	1050	260.7	250	KFBK—Sacramento, Calif.	560	535.4	100	KGER—Long Beach, Calif. (KRLO)	1390	215.7	100
WOAX—Trenton, N. J. (WEAM)	1250	239.9	500	KFBL—Everett, Wash.	1340	227.5	50	KGES—Central City, Nebr.	1470	204.1	10
WOBW—Charleston, W. Va.	1120	267.7	50	KFBM—Trinidad, Colo.	1260	238.0	15	KGEU—Lower Lake, Calif.	1320	227.1	50
WOBW—Union City, Tenn.	1460	205.4	15	KFBP—Laramie, Wyo.	700	428.3	500	KGEW—Fort Morgan, Colo.	1370	218.8	10
WOC—Davenport, Iowa	850	352.7	5000	KFCB—Phoenix, Ariz.	1230	243.8	125	KGEY—Denver, Colo.	1490	201.6	15
WODA—Jamestown, N. Y.	1340	223.7	25	KFCR—Santa Barbara, Calif.	1420	211.1	500	KGEZ—Kalispell, Mont.	1460	205.4	100
WODL—Paterson, N. J. (WGL)	1020	293.9	1000	KFDM—Beaumont, Texas	800	374.8	500	KGFB—Iowa City, Iowa	1340	223.7	10
WOI—Ames, Iowa; 5000, daytime, 6 to 6 (WSUI)	1130	265.3	2500	KFDK—Shreveport, La.	1270	236.1	250	KGFF—Ava, Okla.	1460	205.4	25
WOK—Chicago, Ill. (WMBB)	1190	252.0	5000	KFDY—Brookings, S. Dak. (KMA)	760	394.5	500	KGFG—Oklahoma City, Okla. (KGCB)	1390	215.7	50
WOKO—Peekskill, N. Y.	1390	215.7	250	KFDZ—Minneapolis, Minn.	1300	215.7	10	KGFI—San Angelo, Tex.	1360	220.4	15
WOKT—Rochester, N. Y.	1430	209.7	500	KFEC—Portland, Ore. (KFIF)	1400	214.2	50	KGFI—Los Angeles, Calif. (KFVD)	1440	208.2	100
WOMT—Manitowoc, Wis.	1350	221.1	50	KFEL—Denver, Colo.	1210	247.8	250	KGFK—Hallock, Minn.	1340	223.7	50
WOO—Philadelphia, Pa. (WIP)	590	508.2	500	KFEQ—St. Joseph, Mo.	1300	230.6	1000	KGFL—Trinidad, Colo.	1350	221.1	50
WOOD—Furnwood, Mich.	1150	260.7	500	KFEQ—Kellogg, Idaho	1290	232.4	10	KGFM—Yuba City, Calif.	1420	211.1	15
WOQ—Kansas City, Mo. (WHB)	890	336.9	250	KFEQ—St. Joseph, Mo.	1300	230.6	1000	KGFN—Aneta, N. Dak.	1500	199.9	15
WOR—Newark, N. J.	710	422.3	500	KFH—Wichita, Kansas	1220	245.8	500	KGFO—Terra Haute, Ind.	1470	204.0	100
WORD—Batavia, Ill. (WTAS)	1090	275.1	5000	KFHA—Gunnison, Colo.	1180	254.1	50	KGFP—Mitchell, S. Dak.	1410	212.6	10
WOS—Jefferson City, Mo.	760	394.5	500	KFHL—Oskaloosa, Iowa	1410	212.6	100	KGO—Oakland, Calif.	780	384.6	5000
WOW—Omaha, Nebr.	590	508.2	1000	KFI—Los Angeles, Calif.	640	468.5	5000	KGRC—San Antonio, Texas (KGCI)	1360	220.4	50
WOWO—Ft. Wayne, Ind. (WCWK)	1310	228.9	1000	KFII—Portland, Ore. (KFEC)	1400	214.2	50	KGRS—Amarillo, Texas	1230	243.8	150
WPAB—Norfolk, Va.	1430	209.7	100	KFIO—Spokane, Wash. (KEPY)	1220	245.8	100	KGTT—San Francisco, Calif.	1450	206.8	50
WPCC—Chicago, Ill. (WFKB, WCRW)	1340	223.7	500	KFIO—Yakima, Wash.	1440	208.2	100	KGU—Honolulu, T. H.	1110	270.1	600
WPCH—New York, N. Y. (WRNY)	970	309.1	500	KFIU—Juneau, Alaska	1330	225.4	100	KGW—Portland, Ore.	610	491.5	1000
WPDC—Buffalo, N. Y. (WSVS)	1460	205.4	50	KFIZ—Fond du Lac, Wisc.	1120	267.7	100	KGY—Lacey, Wash.	1230	243.8	50
WPEF—Waukegan, Ill.	1390	215.7	250	KFJB—Marshalltown, Iowa	1210	247.8	150	KHJ—Los Angeles, Calif.	740	405.2	500
WPG—Atlantic City, N. J. (WHAR)	1100	272.6	2500	KFJF—Oklahoma, Okla.	1100	272.6	75	KIK—Spokane, Wash.	810	370.2	1000
WPRC—Harrisburg, Pa.	1430	209.7	100	KFJJ—Astoria, Ore.	1200	249.9	15	KIK—Anita, Iowa	650	461.3	100
WPS—State College, Pa. (WBAK)	1000	299.8	500	KFJM—Grand Forks, N. Dak.	900	333.1	100	KJBS—San Francisco, Calif.	1360	220.4	50
WPSW—Philadelphia, Pa.	1480	202.6	50	KFJR—Portland, Ore. (KTBR)	1060	282.8	100	KJR—Seattle, Wash.	860	348.6	2500
WPTF—Raleigh, N. C.	720	416.4	50	KFJY—Fort Dodge, Ia. (KFMR)	680	409.9	100	KKP—Seattle, Wash.	1130	265.3	15
WQAA—Parkerburg, Pa.	1390	215.7	500	KFJZ—Fort Worth, Texas	1200	249.9	50	KLDS—Independence, Mo.	1110	270.1	1,500
WQAE—Springfield, Vt.	1200	249.9	50	KFKA—Greely, Colo.	750	399.8	200	KLIT—Portland, Oregon	1450	206.8	10
WQAM—Miami, Fla.	930	322.4	750	KFKB—Milford, Kansas	1240	241.8	1000	KLS—Oakland, Calif. (KZM)	1220	245.8	250
WQAN—Scranton, Pa. (WGBI)	1300	230.6	100	KFKU—Lawrence, Kansas (WREN)	1180	254.1	500	KLX—Oakland, Calif.	590	508.2	500
WQAO—WPA—Cliffside, N. J. (WHN)	760	394.5	500	KFKX—Chicago, Ill.	570	526.0	2,500	KLZ—Denver, Colo.	1120	267.7	250
WQJ—Chicago, Ill. (WMAQ)	670	447.5	500	KFKZ—Kirkville, Mo.	1330	225.4	15	KMA—Shenandoah, Iowa (KWKH and KFDY)	760	394.5	1,000
WRAF—La Porte, Ind.	1440	208.2	100	KFLR—Albuquerque, N. M.	720	416.4	100	KMED—Medford, Oregon	1120	267.7	50
WRAH—Providence, R. I.	1500	199.9	250	KFLV—Rockford, Ill.	1120	267.7	100	KMIC—Inglewood, Calif. (KGFH)	1340	223.7	250
WRAK—Escabana, Mich.	1060	282.8	50	KFLX—Galveston, Texas	1110	270.1	100	KMJ—Fresno, Calif.	820	365.6	50
WRAM—Galesburg, Ill. (WFBZ)	1210	247.8	50	KFMR—Sioux City, Ia. (KFJY)	680	409.9	100	KMJ—Clay City, Neb. (WCAJ)	790	379.5	500
WRAY—Yellow Springs, Ohio	880	340.7	100	KFMS—Northfield, Minn. (WCAL)	1270	236.1	500	KMO—Tacoma, Wash.	1180	254.1	250
WRAY—Reading, Pa.	1260	238.0	50	KFNF—Shenandoah, Iowa (KMA)	1110	270.1	1000	KMOX—St. Louis, Mo.	1000	299.8	5000
WRAX—Philadelphia, Pa. (WNAT)	1040	283.3	250	KFOA—Seattle, Wash.	670	447.5	5000	KMTR—Los Angeles, Calif.	570	526.0	500
WRBC—Valparaiso, Ind.	1260	238.0	250	KFON—Long Beach, Calif.	1240	241.8	500	KNRC—Santa Monica, Calif.	800	374.8	500
WRD—Washington, D. C.	640	468.5	500	KFOR—Lincoln, Nebr.	1380	217.3	100	KNX—Los Angeles, Calif.	890	336.9	900
WRD—Washington, D. C. (KFKU)	1180	254.1	750	KFOX—Omaha, Nebraska (KOCH, WNAL)	1160	258.5	100	KOA—Denver, Colo. (10,000 until 7 p. m.)	920	325.9	5000
WREC—Memphis, Tenn.	1180	254.1	50	KFOY—St. Paul, Minn.	1050	285.5	100	KOAC—Corvallis, Ore.	1110	270.1	500
WREN—Lawrence, Kans. (KFKU)	1180	254.1	750	KFPL—Dublin, Texas	1090	275.1	15	KOB—State College, N. M. (KWSC, KTW)	760	394.5	5000
WREO—Lansing, Mich.	1300	230.6	500	KFPM—Greenville, Texas	1300	230.6	15	KOCH—Omaha, Nebr. (WNAL, KFOX)	1160	258.5	250
WRES—Quincy, Mass.	1380	217.3	50	KFPR—Los Angeles, Calif. (KPQZ)	1290	232.4	250	KOCW—Chickasha, Okla.	1190	252.0	250
WRHF—Washington, D. C. (6 a. m. to 6 p. m.)	930	322.4	150	KFPW—Cartersville, Mo.	1140	263.0	50	KOIL—Council Bluffs, Iowa	1080	277.6	1500
WRHM—Minneapolis, Minn. (WDGY)	1150	260.7	1000	KFPY—Spokane, Wash. (KFIO)	1220	245.8	250	KOIN—Portland, Ore.	940	319.0	1000
WRM—Urbana, Ill.; 1000 watts before 6 p. m. (WBAA)	1100	272.6	500	KFQA—St. Louis, Mo.	930	322.4	500	KOLO—Durango, Colo.	1500	199.9	5
WRMU—New York, N. Y. (Portable)	1490	201.6	100	KFQB—Ft. Worth, Texas	1150	260.7	100	KOMO—Seattle, Wash.	980	305.9	1000
WRNY—New York, N. Y. (WPCH)	970	309.1	500	KFQD—Anchorage, Alaska	870	344.6	100	KOWW—Walla Walla, Wash.	1000	299.8	500
WRPI—Terre Haute, Ind.	1440	208.2	100	KFQU—Holy City, Calif.	1200	249.9	100	KPCB—Seattle, Wash. (KGCL)	1300	230.6	50
WRR—Dallas, Texas	850	352.7	500	KFQW—Seattle, Wash.	1280	217.3	100	KPJM—Prescott, Ariz.	1400	214.2	15
WRRS—Racine, Wis.	930	322.4	50	KFQZ—Hollywood, Calif. (KFPR)	1390	232.4	100	KPNP—Muscatine, Iowa	1420	211.1	100
WRS—Chelsea, Mass.	1460	205.4	15	KFRS—San Francisco, Calif.	660	454.3	1,000	KPO—San Francisco, Calif.	710	422.3	1000
WRST—Bay Shore, N. Y. (WCDA, WBRB, WCGU)	1420	211.1	250	KFRU—Columbia, Mo.	1200	249.9	500	KPPC—Pasadena, Calif. (KELW)	1310	228.9	50
WRVA—Richmond, Va.	1420	211.1	250	KFSG—San Diego, Calif.	680	409.9	500	KPRC—Houston, Texas	1020	293.1	500
WSA1—Cincinnati, O.	830	361.2	5000	KFUL—Galveston, Texas	1160	258.5	500	KPSN—Pasadena, Calif.	950	315.6	1000
WSAJ—Grove City, Pa.	1340	223.7	250	KFUM—Colorado Springs, Colo.	1270	236.1	100	KQV—Pittsburgh, Pa. (WJAS)	1110	270.1	500
WSAN—Allentown, Pa. (WCBA)	1350	222.1	100	KFUO—St. Louis, Mo. (KSD)	550	545.1	500	KQW—San Jose, Calif.	1010	296.9	500
WSAR—Fall River, Mass.	1190	252.0	100	KFUP—Denver, Colo.	1320	227.1	100	KRAC—Shreveport, La.	1360	220.4	50
WSAX—Chicago, Ill.	1470	204.0	100	KFUR—Ogden, Utah	1330	225.4	50	KRE—Berkeley, Calif. (KFUS)	1170	256.3	100
WSAZ—Huntington, W. Va.	1240	241.8	100	KFUS—Oakland, Calif. (KRE)	1170	256.3	100	KRLD—Dallas, Texas	1350	222.1	500
WSB—Atlanta, Ga.	630	475.9	1000	KFUT—Salt Lake City, Utah	600	499.7	50	KRLO—Los Angeles, Calif. (KGER)	1390	215.7	250
WSBC—Chicago, Ill. (WWAE)	1290	232.4	500	KFV—Venice, Calif. (KGFJ)	1440	208.2	250	KROX—Seattle, Wash. (KRSC3)	1420	211.2	50
WSBT—South Bend, Ind. (WEMC)	1350	222.1	250	KFVE—St. Louis, Mo.	1280	234.2	1000	KRSC—Seattle, Wash. (KROX)	1420	211.1	50
WSDA—New York, N. Y. (WARS, WBBC)	1320	227.1	250	KFVG—Independence, Kans.	1330	225.4	50	KSAC—Manhattan, Kans.	900	333.1	500
WSEA—Virginia Beach, Va. (WTAR)	1140	263.0	250	KFVI—Houston, Texas	1260	238.0	50	KSBA—Shreveport, La.	1120	267.7	1000
WSIX—Springfield, Tenn.	1410	212.6	150	KFVR—Denver, Colo.	630	475.9	250	KSCJ—Sioux City, Ia. (KWUC)	1230	243.8	500
WSKC—Bay City, Mich.	610	491.5	250	KFVS—Cape Girardeau, Mo.	1340	223.7	500	KSD—St. Louis, Mo. (KFUC)	550	545.1	500
WSM—Nashville, Tenn.	880	340.7	5,000	KFWB—Los Angeles, Calif.	830	361.2	500	KSEI—Pocatello, Idaho	900	333.1	250
WSMB—New Orleans, La. (WAAT)	930	322.4	500	KFWC—San Bernardino, Calif.	1350	222.1	250	KSL—Salt Lake City, Utah	990	302.8	1000
WSMK—Dayton, O.	1010	296.9	200	KFWF—St. Louis, Mo.	1400	214.2	250	KSMR—Santa Maria, Calif.	1100	272.6	100
WSOE—Milwaukee, Wis.	1100	270.1	600	KFWH—Eureka, Calif.	1180	254.1	100	KSO—Clarinda, Iowa	1320	227.1	500

Radio University

A FREE Question and Answer Department conducted by RADIO WORLD for its yearly subscribers only, by its staff of Experts. Address Radio University, RADIO WORLD, 145 West 45th St., New York City.

When writing for information give your Radio University subscription number.

I BUILT a receiver like that described on page 14 of RADIO WORLD for Aug. 27. I used a 50,000 ohm rheostat in the plate circuit of the first tube and I connected the by-pass condenser C1 between rheostat Rh2 and coil L1. At first this circuit worked wonderfully, but suddenly it lost its sensitivity. The first tube does not seem to have any effect on the signals. If I connect an antenna to the grid of that tube and tune the circuit I get no signals. If I connect the antenna to the plate of the first tube the signals are very loud. The tube is good. What is the reason for this misbehavior of the circuit?

ALBERT SINGLETON,
Rochester, N. Y.

The cause of the trouble is a defective rheostat. Rh2 is open all the time so that the first tube does not get any plate voltage.

* * *

I AM building a receiver with one stage of radio frequency and a regenerative detector. The audio amplifier will be resistance coupled. I want to use a rheostat with which to control the volume. Which is better, to put both the R.F. and the detector on the rheostat or the R.F. tube only?

(2) What should the resistance of the rheostat be to serve as a volume control when -01A tubes are used?

(3) What should the resistance be if 99s are used?

(4) Is it possible to connect all the plate returns in the receiver to a common high voltage binding post and then use resistors to cut the effective voltage on the detector and R. F. tubes?

A. B. DEE,
Los Angeles, Cal.

(1) It is better to put the first tube alone on the rheostat and put the detector on a fixed ballast resistor, because at times it is desirable to cut out the first tube entirely.

(2) Twenty ohms will control the volume very well, but it is advisable to put a fixed ballast in series with the rheostat so that the filament current cannot exceed the normal value of .25 ampere.

(3) With a 99 tube in the first socket the rheostat should be about 100 ohms in addition to an Amperite which cuts the voltage from 6 to 3 volts.

(4) Yes, it is possible and practical to bring all the plate returns to the same binding post, even if the voltage applied is as high as 180 volts. The resistance required in series with the plate lead to any tube would depend on the type of tube, on the applied voltage and on the

effective voltage desired. Suppose the tube is a -01A and the desired voltage is 45 volts. If the applied voltage is 180 the resistance must be enough to drop 135 volts. When the voltage is 45 on the plate of a -01A tube and the bias on the grid is 1 volt, the plate current is about 5 milliamperes. Hence the resistance should be 27,000 ohms. It makes little difference whether a 25,000 or a 50,000 ohm resistor is used because the tube is not critical. The resistor should be by-passed with a condenser of about .001 microfarad. In a resistance coupled amplifier it is not necessary to insert another resistor in the plate circuit of the detector since the coupling resistance is high enough. But this may have any value from .1 to 1 megohm.

* * *

I GET fairly good results with my receiver when I use dry cell B batteries but when I try to use a B battery eliminator the quality is very bad. Volume is also low and there is a tremendous amount of hum. The eliminator is all right because it operates other sets without hum. What is the cause of this trouble?

RAGNAR SODERHOLM,
St. Paul, Minnesota.

The symptoms are indicative of radio frequency oscillations in the receiver. The frequency may be very high, and is either in the radio frequency tube or in the detector. It might even be in the audio amplifier. No tube amplifies well when it oscillates, and hence if one tube in the circuit oscillates, the volume will be low.

* * *

I HAVE constructed a phonograph pick-up for use in connection with my audio amplifier. The volume I get out of it is tremendous, but there is too much needle scratch. I understand there is a circuit arrangement whereby the scratch can be filtered out. Will you kindly show me a hook of such a filter.

(2) Please give the essential parts of the filter so that I can build it myself.

(3) If you will explain the principle of the filter I would appreciate very much.

HARRY A. ASHMUN,
Springfield, Ill.

(1) See Fig. 565 for such a circuit.

(2) The essential elements of a scratch filter are the same as the elements of a low pass filter, namely, series inductances and shunt condensers. The scratch filter

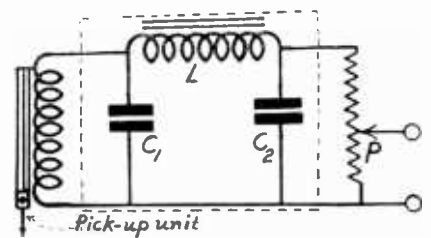

FIG. 565

The scratch filter circuit requested by Harry A. Ashmun. The filter consists of two .005 mfd. condensers and one 85 millihenry choke coil.

indicated in Fig. 565 contains one 85 millihenry choke coil and two .005 mfd. condensers.

(3) The principle of the scratch filter is readily understood when it is recalled that the scratch consists chiefly of audio frequencies above 10,000 cycles and that the desired frequencies are much below that. The object of the filter is to prevent the high frequency currents from reaching the amplifier and at the same time to let the lower frequency currents through without much attenuation.

In Fig. 565 C1 by-passes most of the high frequency current. The choke coil L throttles down any high frequency currents which would pass into the line. Condenser C2 aids the coil in this action and at the same time by-passes. Hence the high frequency currents passing through the potentiometer P are very minute and are not strong enough to give rise to any hissing or scratching noises in speaker.

* * *

WHENEVER I touch the loudspeaker base or the plate binding post of the last tube there is a terrific high pitch squeal. I note a similar squeal when I touch the detector tube, or even when I come near to it with my hand. I have a Diamond of the Air set in which the detector and first audio are resistance coupled. What is the cause of the squealing?

—RAYMOND BALL, Jefferson City, Mo.

The squeal is due to blocking of the grids, and that in turn is due to radio frequency oscillation. There is a great deal of radio frequency feed back, and also radio frequency amplification in the audio amplifier. The feed-back is increased when you touch the speaker and when you point to the detector tube. The first thing that should be done in a case like this is to filter the radio frequency currents out of the signal that is transmitted to the audio amplifier. That can be done with a low pass filter like that described in RADIO WORLD, Aug. 27, page 10. It may be that this alone will not stop the trouble because the grids of the audio tubes are coupled too closely to high potential radio frequency leads. Shielding at critical places will then help. Shields should be grounded. Even if the circuit does not squeal when it is in this condition, the radio frequency currents present in the audio amplifier will make the operation of the circuit erratic.

* * *

RECENTLY I noticed that the volume in my receiver had dropped very low. I tested everything and found that one 45-volt B battery in a group of three had been run down to 30 volts. The others showed about 36. I only bought one new battery and installed it. The set worked all right for a while, but after a month and a half of operation, the volume again began to drop. Upon inspection, I found that all three B batteries including the new one were run down. Was this due to the installation of old batteries with a new one, or was it due to the new B battery being a poor one?

HARRY MERLERS,
Jacksonville, Fla.

It was due to the installation of a run-down battery with a good one.

Join RADIO WORLD'S University Club

And Get Free Question and Answer Service for the Coming 52 Weeks
This Service for Yearly Subscribers Only

Have your name entered on our subscription and University lists by special number. Put this number on the outside of the forwarding envelope (not the enclosed return envelope) and also put at the head of your queries. If already a subscriber, send \$6 for renewal from close of present subscription and your name will be entered in Radio University. No other premium given with this offer.

[In sending in your queries to the University Department please paragraph them so that the reply can be written under or alongside of each query. Write on one side of the sheet only. Always give your university number.]

RADIO WORLD, 145 West 45th Street, New York City.
Enclosed find \$6.00 for RADIO WORLD for one year (52 nos.) and also enter my name on the list of members of RADIO WORLD'S University Club, which gives me free information in your Radio University Department for 52 ensuing weeks, and send me my number indicating membership.

Name

Street

City and State.....

Radio World's Fair as Dazzling as a Circus

Miracles of electrical and wireless science, in dazzling array, that have amazed even the research wizards of the world, are features of the Radio World's Fair in Madison Square Garden, New York (Sept. 19 to 24).

The visitors have the thrill of listening to the atom! Flowers talk, with a roar like thunder, their sounds being divulged through amplification millions upon millions of times.

Even a radio wave is depicted by a supersensitive machine and a full illustration of what a wave actually does is given.

Cold heat is transmitted through the air.

A few statistics tell their own story:
 Number of exhibits—300.
 Number of new receivers on display—2,000, costing from \$35 to \$3,000.
 Value of accessories shown, batteries, tubes, loudspeakers, etc.—\$500,000.

Floor space used—50,000 square feet (no more is obtainable).

Cost of opening the show—\$100,000, decorations alone \$35,000.

Visiting jobbers and dealers—10,000 from every state in the union, every province in Canada, each country in Europe, and from Australia, New Zealand, China, Japan, India, etc.

Amount of business contracts between manufacturers and agents during business sessions—\$100,000,000.

Cost of installing the Crystal Studio for Broadcasting—\$7,500. From this point are transmitted programs over the chains and other stations to half the country.

Artists, announcers, and station directors in attendance—1,000.

Estimated cost of the exhibits by manufacturers—\$500,000, with an equivalent amount expended for the expenses of big staffs of men, some coming from as far as the Pacific Coast.

Teacher New Queen During 1927-8 Term

The new Radio Queen of America is Edith Amelia Smith, high school teacher of Hamilton, Md., who was notified of her honors at the Hotel Astor by G. Clayton Irwin, Jr., general manager of the Radio World's Fair, where she is guest of honor. Miss Smith succeeds Mrs. Lotta Harrauff of Princeton, Ill.

Miss Smith won the nation-wide essay

test conducted by the Radio World's Fair. Miss Smith won first honorable mention in last year's competition.

THE ACME WIRE CO.
 NEW HAVEN, CONN.
 "Celatsite" Products
 Parvult Condensers
 Booth HH-7



Algonquin Electric Co., Inc.
 245 FIFTH AVENUE NEW YORK CITY
 Manufacturers
 Algonquin Speakers
 Algonquin Remote Controls
 Thermodyne 7-Tube Totally Shielded Sets
 Booths 16 and 17 Section E. E.

"ENSCO" 3-FT. CONE KIT
 "The Original, and, of course, the Best"
 Welcomes You at Booth 5, Section W
Engineers' Service Company
 25 CHURCH ST. N. Y. CITY
 F. F. Webb Clyde V. Fitch
 Fred Klingenschmitt

STONER & HEATH, INC.
 122 Greenwich St., New York City
 Eastern Sales Agents for
 CENTRAL RADIO LABS. BODINE ELEC. CO.
 IGRAD COND. & MFG. CO. HALLDORSON CO.
 ELLIS ELEC. LABS. DE LUXE MFG. CO.
MASTERCRAFT PRODUCTS CO.
 W. Scharf BOOTH DD-3 G. W. Hoehn

HAMMARLUND MFG. CO.
 424-438 West 33rd Street, New York City
 For Better Radio
 HAMMARLUND PRECISION PRODUCTS
 Booth D. D. 9

Atwater Kent Mfg. Co.
 PHILADELPHIA, PA.
Radio Sets and Speakers
 Booth 1, Section G, Arena Floor
 T. W. MacDowell in Charge of Booth

LYNCH
Resistors
 Booth F.F.7 Jim Kennedy in Charge

Jobber Appointments For Frost and Remler
 Pat Kiley announces to the trade the appointment of the following exclusive distributors in New York and vicinity on the well-known products of Herbert H. Frost, Inc., and Remler products: Wholesale Radio Service Co.; Radio Jobbers, Inc.; R. H. McMann, Inc., and Allen-Rogers. These are all high-calibre concerns, well-known in the trade and with wide distribution. They will undoubtedly do justice to these excellent lines. In line with his effort to best serve the trade Mr. Kiley also announces the appointment of an assistant to himself, Mr. E. Lynn Dunlap. Mr. Dunlap is an electrical engineer and a graduate of Syracuse University. He will do missionary work among the dealers and will lend them every assistance in solving their problems and helping to move merchandise. Pat Kiley, who is a dynamo of energy and optimism, has been on the job all summer and reports a record summer business on Frost and Remler parts with a splendid outlook for Fall.—J. H. C.

WEIL GETS POLYMET ACCOUNT
 The Polymet Manufacturing Co. of New York, makers of radio parts, have placed their advertising account with Paul S. Weil of Albert Frank & Co. Radio trade and consumer magazines as well as newspapers in the larger cities will be used.
 Polymet is planning quite an extensive campaign.

GENERAL RADIO CO.
 CAMBRIDGE, MASS.
GENERAL RADIO
 PARTS and ACCESSORIES
 Best Suited to Serve You
 BOOTH V. 2
 Ask for WM. GAWLOR

KARAS ELECTRIC CO.
 4040 N. Rockwell St. Chicago, Ill.
 Transformers, Condensers and Dials
 Specified in Leading Circuits
KARAS EQUAMATIC
 Booth B.B.21 Bob Eglaston in Charge

National Company, Inc.
 W. A. READY, President
 MALDEN, MASS.
 Buy
NATIONAL Radio Products
 BOOTH F. F. 5—W. H. READY in Charge

ACME APPARATUS CO.
 37 Osborne Street
 CAMBRIDGE, MASS.
A C M E
 For Amplification—Booth B. B. 9

The George W. Walker Co.
 2825 Chester Ave., CLEVELAND, O.
VICTOREEN
 RADIO PRODUCTS
 At Booth: E. A. Benson
 BOOTH NO. 8 J. A. Victoreen
 SECTION H H C. J. Victoreen
 R. A. Carlton

The Hartzell Sales Company
 International Sales Distributors
 50 CHURCH STREET N. Y. CITY
 SALES DEPARTMENT FOR
 Acme Wire Co.; Best Mfg. Co.; Corbett
 Cabinet Mfg. Co.; Lignole Corp.; Perry
 Wire Works; Victoreen Radio Co.
 Booth 5 to 8, inclusive—Section H H
 In charge—C. C. Hartzell, B. D. Champe

Balsa Reproducer Corp.
 331 MADISON AVE. NEW YORK CITY
LATA BALSA WOOD
 Nature's Sounding Board
 Booth C. C. 2
 E. J. Chambers in Charge of Booth

American Mechanical Labs., Inc.
 Makers of
CLAROSTAT
 the Greatest Variable Resistor
 Bids you Welcome to Booth 5
 Section G. G., Exposition Floor
 J. J. Mucher, Pres.; C. Golenpaul, Sales Mgr.

EC
RADIO TUBES
 Make a Good Receiver Better
C. E. MFG. CO.
 Booth GG 5
 H. H. Steidle in charge of Booth



WHY CALL LETTERS?

The custom of designating each station by call letters is a survival of the sea. It was much easier for a ship to identify itself, or to call another by using a combination of three or four letters than by spelling out its name.

End Radio Bothers

DO YOU KNOW what's wrong when your radio set isn't working right? Ten to one, you don't. Twenty to one, you would if you had a copy of

Hoff's Radio Trouble Finder



Just hear of M. M. Hoff, radiotrician, of Philadelphia? He was one of the very first "radio bugs" and has been building and studying sets ever since. And now, out of his broad experience, this man has written a book to tell radio owners how to keep

their sets working right. He tells in plain words and illustrations how a set is made, what the parts are called, what are the few usual troubles and how to fix them. Then he lists 103 troubles that sometimes happen and tells how to detect and fix each one. The book is a regular cyclopedia of radio information—only it's in language anyone can understand. Read it five minutes and you'll know more about radio than you ever dreamed of.

You Need This Book

It will save you many a repair man. It will save you hours of guessing and fusing and fuming. It will help you keep the tone of your set always sweet and strong. It will keep you from losing many programs. And, best of all—**IT WILL MAKE YOU STOP SWEARING MUCH TO THE SURPRISE OF YOUR FAMILY** because radio repairs are expensive. Why hire them done when you can easily learn how to keep your set from needing them?

All It Costs Is \$1

Send cash with your order and you get also a Dictionary of Radio Terms and the latest list of Radio Broadcasting Stations with call letters and the new Federal Radio Commission wave lengths. Send your dollar today while the copies last.

WALT C. WHITE, Distributor
Quincy Bldg., Chicago

Better by Far

Than any fixed leak in the detector circuit is the

BRETWOOD

VARIABLE GRID LEAK



Because it allows adjustment of grid voltage to maximum sensitivity for reception of far-distant signals, while permitting faster discharge of electrons when receiving strong local stations, thus preventing distortion from this cause. Therefore a Bretwood Variable Grid Leak means more miles plus best possible tone quality, without any extra tubes. A patented plastic and foolproof plunger insure permanence in holding any desired resistance setting from .25 to 10 megohms, as well as very long life of the leak itself. As no grid leak can function any better than its grid condenser, be sure that you use a leak-proof Bretwood Bullet Condenser, of mica dielectric, and of .00035 mfd. capacity (another precision product, accurate to plus or minus one per cent.). Get these two parts and also get our

FREE

hookups, supplied with each purchase. Just fill out and mail the attached coupon.

Don't Send a Solitary Cent!

The Bretwood Leak may be baseboard or panel mounted. Works the same in any position. No fluid used.

North American Bretwood Co.,
145 West 45th Street, N. Y. City.

Please mail me at once one New and Improved 1928 Model De Luxe Bretwood Variable Grid Leak (price, \$1.75) and attach one Bretwood Bullet Condenser (50 cents extra), for which I will pay the postman \$2.25 on receipt. Both must be the genuine Bretwood articles, imported from England.

NAME

STREET ADDRESS

CITY STATE

RW-917

Moulded Condensers

Made by Aerovox

The Aerovox Wireless Corporation of 70 Washington St., Brooklyn, has added a new line of moulded Bakelite condensers to their



extensive line of radio products. The condensers are held to a predetermined accuracy of plus and minus 10%. They are unaf-

ected by extreme changes in temperature, moisture and chemical action. They come in two types, .00004 to .02 mfd. and .03 to .1 mfd. The smaller condensers are equipped with eyelets and soldering lugs for mounting either with screws or direct soldering. The large type has soldering lugs on top and screw holes for mounting in a horizontal plane.



New Benjamin Socket

The Benjamin Electric Company of Chicago has a five-prong socket to accommodate the new AC detector tube, UY227 and CY327.



The socket is characteristic of the Benjamin products in that the tube is suspended on vibration-killing springs, which render reception free from microphonic noises.

KITS For all known circuits. Get our Special prices on Kits and save money. All RADIO WORLD Kits. DIAMOND of the AIR KIT...\$37.50 Send for FREE RADIO CATALOG B. C. L. RADIO SERVICE CO., INC. 221 FULTON STREET NEW YORK CITY

2100 intelligent questions

2100 correct answers

Ratings of 62 celebrities

and

THE SUPER-TEST

Ask Me Another

Series 2

The second question book

THE VIKING PRESS

Sent postpaid for \$1.00. THE COLUMBIA PRINT 145 W. 45th St., New York City.

Literature Wanted

THE names and addresses of readers of RADIO WORLD who desire literature on parts and sets from radio manufacturers, jobbers, dealers and mail order houses are published in RADIO WORLD on request of the reader. The blank below may be used, or a post card or letter will do instead.

RADIO WORLD,
145 West 45th St., N. Y. City.

I desire to receive radio literature.

Name

Address

City or town.....

State

- H. P. Dahlen, 1700 N. Sixth St., Terre Haute, Ind.
- William McKeever, 930 Cherokee St., Pittsburgh, Pa.
- J. Homa, 82 Stratford Place, Newark, N. J.
- L. J. DuBois, 7 West 15th St., Jamestown, N. Y.
- W. Willis, 156 Oxford St., Brooklyn, N. Y.
- J. D. Auberteuil, 1217 Almonaster Ave., New Orleans, La.
- H. Wong, 900 Grant, San Francisco, Calif.
- C. Vanderveen, 15012 Marshfield Ave., Harvey, Ill.
- W. C. Saner, 9014 Lowe Ave., Chicago, Ill.
- Louis E. Willard, R4, B344, Pine Bluff, Ark.
- Billy Fitzgerald, 219 Elm St., Minden, La.
- J. Knapp, 21 Connaught Ave., Toronto, Ontario, Canada.
- William T. Yates, 1038 West Stakes St., Danville, Va.
- Peter Davis, Jr., 814 Franklin Place, Milwaukee, Wis.
- A. F. Van Drake, 8416 Independent Ave., Kansas City, Mo.
- J. Bandzi, 145 W. Westfield Ave., Roselle Park, N. J.
- Milton Rowles, 3316 Ravenwood Ave., Baltimore, Md.
- Albert Hinz, Linden Hill Station, R2, Minneapolis, Minn.
- Sewell Electric Co., 2127 W. Hill St., Louisville, Ky.
- T. F. Knittel, 1928a Wyoming St., St. Louis, Mo.
- George Harrington, R. F. D., Coldwater, N. Y.
- M. H. Muldoon, 1125 East 125th St., No. 10, Cleveland, O.
- R. I. Weaver, 433 High St., Clarksburg, W. Va.
- W. G. Hilton, 317 N. Main St., Winston-Salem, N. C.
- Richard B. Martin, 336 East 5th St., N. Y. City.
- Edward Berberich, 4427 Minnesota St., St. Louis, Mo.
- R. W. Hasse, 703 Bancroft, St. Louis, Mo.
- Marvel Radio Co., 32 Saratoga St., Springfield, Mass.
- H. E. Campbell, 3215 De Sote St., Shreveport, La.
- Lewis W. Walters, Box 476, Rossford, O.
- Harold E. Smith, 15th Signal Service Co., Fort Monmouth, N. J.
- Grover C. Nibouar, 124 Wellens Ave., Philadelphia, Pa.
- W. E. Heatoro, Balfour, N. C.
- Harry G. Finlay, 5077 Page Ave., St. Louis, Mo.
- Fred Spille, 315 S. Webb St., Webb City, Mo.
- J. W. Cruss, 5240 Indiana, Chicago, Ill.
- H. A. Remine, 756 Shring St., Macon, Ga.
- Frederick P. Graves, 158 Chamberlain Ave., Bridgeport, Conn.
- Melvin S. Lindberg, 330 S. 7th St., De Kalb, Ill.
- C. Brown, 19 Lincoln St., Lowell, Mass.
- Carlisle Horning, 20 Clinton St., Castile, N. Y.
- J. F. Hupp, New Lexington, O.
- Richard Shutts, Sulphur Springs Station, Tampa, Fla.
- P. J. LeGrand, 3326 Charlton St., Chicago, Ill.
- F. A. Thyll, 1848 Monroe Ave., N. Y. City.
- William J. Grieg, 448 Washington St., Norwood, Mass.
- Warren Hoff, Maple Ave., Vineland, N. J.
- Edward Berkoben, 218 Welsh Ave., Wilmerding, Pa.

JAYNIXON LABORATORIES

W. J. McCord, Chief, 57 Dey St., N. Y. C.

ACCURATE RADIO REPAIRS
Sets Built to Order—Speakers and Magnets Repaired—Electrification Experts

OFFICIAL SERVICE on
Unified Diamond Strobodine
Victoreen Knickerbocker
One-Dial-Witz Ambassador

Approved by RADIO WORLD

TEL. CORT. 5112

Standardized Frequency As Established by G. E.

By *W. A. Ford*

General Engineering Laboratory, General Electric Co.

[For the past 49 months WGY has maintained its assigned frequency with an average deviation, according to the Bureau of Standards, of one-tenth percent. The frequency of WGY has been measured by the Bureau 216 times and it was the first standard frequency station announced and has been continuously listed as a standard station. In maintaining frequency WGY's engineers have been assisted by the engineers of the General Engineering Laboratory of the General Electric Company who have done some exceptional work in frequency standardization.]

Frequency in this and most European countries is determined by the length of the sidereal day. A good clock as a standard of frequency would be excellent as to accuracy but there remains, however, the problem of comparing the frequency of, say, the swinging pendulum, with the much higher frequencies of the alternating currents as used for radio transmission.

An alternating current of one cycle per second could readily be obtained from the fork, but when this frequency is multiplied millions of times any irregularity in the period of successive cycles due to contracts, etc., would result in correspondingly larger errors in the final measurement.

The simplest way of reducing this error is to make the primary frequency as high as the demands of the work require, in this way reducing the amount of multiplication necessary.

In addition to this a driving force which is extremely uniform will also improve the accuracy.

For most of our work frequencies differing by 1,000 cycles are sufficient for calibration purposes.

A 1,000 cycle tuning fork was therefore
(Concluded on page 26)



Trade Mark Reg'd U. S. Pat. Office

CONDENSERS

"Superior to all others tested!"

Recognized Radio engineers have for a long time known the excellence of TOBE Condensers. They have the quality of continuing to function perfectly over long periods of time.

Now the TOBE No. 662 high voltage condenser block has been selected exclusively by McMurdo Silver for use with the new Silver Marshall UNIPAC and Mr. Silver has written us:

"It is indeed a pleasure to inform you that on completion of our test we find that the condenser blocks that you have submitted have proven exceptionally satisfactory and, insofar as we can determine, superior to all other condenser banks which we have tested."

Send for price list N-10

Tobe Deutschmann Co.

Engineers and Manufacturers of
Technical Apparatus
CAMBRIDGE, MASS.

The New
3 Ft. Cone
Loud
"ENSCO"
Wall Type
Speaker



"The World's Finest Loud Speaker"

Never before in the history of Radio has there been a more outstanding success. The "Ensco" 3-foot Cone has been the wonder of the leading Radio Engineers. The faultless tone, reproducing perfectly every musical frequency, has astonished many leading artists.

Build It Yourself From The "ENSCO" Kit

The "Ensco" is sold only in kit form. Every necessary part is included in the kit. The "Ensco" unit, designed and patented by Clyde J. Fitch, is the only direct-drive unit which satisfactorily operates a 3-foot cone. No soldering necessary. Six styles and three sizes to choose from, all described in the illustrated instruction book, which is included with every kit. Assembled in less than an hour.

STANDARD KIT \$10.00

With Hardwood Frame \$11.00

See the "ENSCO" at the Radio Shows

The famous "Ensco" is being shown at the Radio Shows in New York, Boston and Chicago. See our exhibit—look over the various styles—study the simple, practical, patented "Ensco" Unit.

At Your Dealer or Direct From Us

Go to your dealer's store today—hear the "Ensco" in competition with any other speaker regardless of price. To hear it, is to buy it.

If your dealer hasn't been supplied, you may send your order direct to any of the offices listed below. Send Check, Money Order or C. O. D. (shipping charges paid.) In Canada, the prices are \$11.50 and \$12.50. You take no chance when you order direct, our money back guarantee protects you.

Engineers' Service Co.

25 CHURCH STREET, NEW YORK
28 EAST JACKSON BOULEVARD, CHICAGO
73 CORNHILL, BOSTON
331 BAY STREET, TORONTO, ONTARIO

Take Your Choice of 7 Other Publications

For NEW RADIO WORLD Subscribers Ordering NOW

Radio World has made arrangements

—To offer a year's subscription for any one of the following publications with one year's subscription for RADIO WORLD—

RADIO NEWS or POPULAR RADIO or SCIENCE AND INVENTION or BOYS' LIFE or RADIO DEALER or RADIO (San Francisco) or RADIO AGE.

This is the way to get two publications

- for the price of one:
- Send \$6.00 today for RADIO WORLD
- for one year (regular price
- for 52 numbers)
- and select any one of the other
- nine publications for twelve months.
- Add \$1.00 a year extra for
- Canadian or Foreign Postage
- Present RADIO WORLD subscribers
- can take advantage of this offer by
- extending subscriptions one year
- if they send renewals NOW!

Radio World's Special Two-for-Price-of-One Subscription Blank

RADIO WORLD, 145 West 45th Street, New York City.
Enclosed find \$6.00 for which send me RADIO WORLD for twelve months (52 numbers), beginning and also without additional cost, Popular Radio, or Radio News, or Science and Invention, or Radio Dealer, or Radio (San Francisco), or Radio Age, or Boys' Life (or \$10.00 for a two-year subscription to one address). No other premium with this offer.

Indicate if renewal. Name
Offer Good Until Street Address
Nov. 20, 1927. City and State

Good Back Numbers of RADIO WORLD

The following illustrated articles have appeared in back issues of RADIO WORLD in 1927.

MAY 21.—Part I of a three-part article on the Victoreen Portable receiver, by Capt. P. V. O'Rourke. Data on the new Raytheon cartridge.

MAY 28.—A three-tube reflex, using a special low pass filter system, by Edgar B. Francis. Part II on the Victoreen portable receiver with layout data, by Capt. P. V. O'Rourke.

JUNE 4.—Part III of a three-part article on how to construct an efficient portable Victoreen Super-Heterodyne, by Capt. P. V. O'Rourke. A complete discussion on the RCA AC tubes.

JUNE 11.—Detailed discussion of a four-stage push-pull resistance coupled audio amplifier, by J. E. Anderson. The Suitcase 6, using a tuned RF stage, two untuned RF stages, regenerative detector and two transformer AF stages, by James H. Carroll. Balsa Wood for speakers, an excellent discussion on how this wood may be employed for speakers, by H. B. Herman.

JUNE 18.—The six-tube Equamatic, a neutralized two-stage tuned RF, three-stage AF resistance coupled set, by Herbert E. Hayden. How to get the low notes with transformer or impedance AF, by Dennis J. O'Flaherty.

JUNE 25.—The Lindbergh Plane Speaker, an excellent cone type reproducer, by Herbert E. Hayden. A tube and set tester, by Herman Bernard.

JULY 2.—The Planofier 7, single control super-sensitive set using resistance AF by R. F. Goodwin and S. S. Bruno. Discussion on the new Freshman Equaphase, by Robert Sagala. Data on the six types of units used for loud speaker operation, by J. E. Anderson.

JULY 9.—How to build a DC A supply where the line voltage is 220 or 240, by Frank Logan. Important data on RF choke coils, by Horatio W. Lamson.

JULY 16.—How to use a voltmeter as a milliammeter, by D. Barretti. How to build a 4-tube, 2-control regenerative portable set.

JULY 23.—Building a 7-tube Super for your auto, using Victoreen IFT, by John F. Rider (Part I). How to build a 6-tube neutralized set, using three tuned RF, two transformer AF, by John F. Rider. Inside dope on motorboating, by J. E. Anderson.

JULY 30.—A 5-tube standard TRF set adapted to AC operation by the use of the QRS 400 mill rectifier tube, with the aid of series filament connections, by RF Goodwin and S. S. Bruno. Shielding the 11-tube Melo-Heald Super-Heterodyne receiver, by Clifford Denton. Part II of the two part article on the Super in the auto by John F. Rider. How to control volume in AC sets by D. Ferrup.

AUG. 6.—A three-tube regenerative portable with portion of the cabinet as the speaker, by M. J. O'Reilly. The Cashbox Unitone, an ingeniously contrived four-tube quality receiver by Wendell Buck. How to use AC tubes by C. T. Burke.

AUG. 13.—Hints on constructing a portable set, by Herbert E. Hayden. A seven-tube, two-control AC operated receiver by Capt. P. V. O'Rourke. Obtaining the C bias in an ABC unit, using the BA Raytheon 85 mill tube.

AUG. 20.—The Four AC, a four-tube regenerative set employing AC tubes. Tim Turkey's argument on why rheostats should not be used as volume controls. The Drum Powerstone, a five-tube single control set, using resistance coupled audio.

AUG. 27.—Part I of a four part article on building the 1-Dial Witz, a single control, voluminous selective 5-tube set, by A. Irving Witz. A detailed explanation of the exponential type of horn by H. B. Herman. Details on the revolutionary Reisz condenser type of speaker. Constructional data on a special 5-tube, 2-dial regenerative set, with three stages of AF, by Tim Turkey.

SEPT. 3.—Part I of a four-part discussion on the new 1928 Victoreen Universal, a super-sensitive 8-tube Super-Heterodyne, by Capt. P. V. O'Rourke. Complete data on the three types of phonograph pickups, by J. E. Anderson. Part II of the 1-dial Witz, wiring hints emphasized.

SEPT. 10.—The Puratone AC set, a 6-tube duo-control receiver, using AC tubes, by R. F. Goodwin and S. S. Bruno. Part II of the 1928 Victoreen Universal, discussing the placement of parts. Part III of the 1-Dial Witz on the special placement of the coils.

Any Copy 15c. Any 7 copies, \$1.00 All these 17 copies for \$2.10, or start subscription with any issue. Any 8 of these numbers sent as premium with NEW yearly subscription. No other premiums allowed. RADIO WORLD, 145 West 45th St., New York City.

Synchronous Motor Standardizes Frequency

(Concluded from page 25)

chosen as the primary standard to be electrically driven by suitable vacuum tube amplifiers, thus providing a means of driving which is loosely coupled to the fork and will have the minimum effect upon it.

This fork is mounted in a temperature controlled cabinet and suitable meters provided for holding driving voltages constant.

Now that a primary standard source of alternating current has been provided some means of determining its absolute value is necessary. This is accomplished as follows:

The output of the fork-driving amplifier is coupled to a power amplifier which drives a 1,000 cycle synchronous motor which is geared to a counter. It is now possible to compare the revolutions of

the synchronous motor and consequently the number of cycles of the fork to a known interval of time. This is best done by tuning the fork and motor over a period of 10 or 24 hours as measured by comparison with transmission of time signals from the U. S. Naval Observatory transmitted by radio station at Arlington, Va.

A receiver is set up and the readings of the counter made at the start and finish of the test period. The number of seconds in this period may be computed, then by dividing the number of revolutions of the motor by the number of seconds in the test period, the frequency of the fork is obtained.

By repeated measurements on successive days an accurate knowledge of the constancy from day to day is obtained.

For short periods of time the constancy of the fork has been determined by a chronograph and standard clock.

Having determined the absolute frequency of the 1,000 cycle fork means must be provided for multiplying this frequency to the magnitude of frequencies used by Radio Stations. This is done by coupling the output of the fork to a 1,000 cycle oscillator, using sufficient voltage to synchronize or pull into step this oscillator.

This oscillator is designed to produce rich harmonics of the 1,000 cycle fundamental. The tenth harmonic or 10,000 cycle voltage is selected and used to control a 10,000 cycle harmonic generator whose tenth harmonic or 100,000 cycle voltage is used to control a 100,000 harmonic generator and so on, as far as the requirements demand.

Suitable means is also provided for the selection and comparison of any frequency in 1,000 cycle steps throughout this range.

This apparatus consists of a frequency generator (sine wave) which is variable over the entire frequency range; a variable tuned circuit selector and an audio amplifier with visual or audible beat indicator.

The sine wave generator is provided with a straight line frequency vernier condenser which provides a means of obtaining frequency steps between the 1,000 cycle steps readable to 20 cycles in the range of broadcasting frequencies.

These intermediate frequencies may also be measured by the Campbell Audio Frequency Bridge or harmonics from a 100 cycle electrically driven fork both of which are provided as part of the standardizing equipment.

Yale GROUND HOG

DOUBLES POWER AND DISTANCE

Marvelous newly-invented ground gives incredibly improved reception. Doubles power and distance users say. Reduces leakage. Stops jangling even in midsummer. Results never before equaled. Satisfaction guaranteed or money back at once. Proven absolutely essential to clear, powerful distance reception. Draws and holds moisture indefinitely. Highly sensitive to radio energy. **SEND NO MONEY**—To introduce, we offer to those who act at once, regular \$5.00 size for only \$2.95. Send name today and pay \$2.95 plus postage on delivery. Or send only \$2.95 with order and save postage. **FREE**—Full description of Ground Hog on request—write today. Dealers—Write for attractive proposition and prices. Yale Specialty Supply Co. 3840 Main St. Kansas City, Mo.



25 Cents

Brings ALL THIS!

One Official Blueprint of the Five-Tube Diamond of the Air

One official booklet describing in detail how to build this famous set, wind coils, etc.

Act Now! Send That Quarter to

RADIO WORLD

145 WEST 45th ST. NEW YORK CITY

Do you want to complete your files for Radio World?—Any copy that you missed during the past Summer will be supplied @ 15c. the copy, or any 7 copies for \$1.00, or you can start your subscription with any issue. Circulation Dept. Radio World, 145 W. 45 St., New York City.

FILL OUT AND MAIL NOW

SUBSCRIPTION BLANK

RADIO WORLD

RADIO WORLD

145 West 45th Street, New York City
(Just East of Broadway)

Please send me RADIO WORLD for months, for which

please find enclosed

SUBSCRIPTION RATES:
 Single Copy \$.15
 Three Months 1.50
 Six Months 3.00
 One Year, 52 Issues 6.00
 Add \$1.00 a Year for Foreign Postage; 50c for Canadian Post age.

Bullard Says South Gets a Square Deal

Washington.

Chairman William H. G. Bullard, of the Radio Commission, in a letter to a correspondent in the South, disclaims any responsibility on the part of the Commission for alleged discrimination against the South in the matter of broadcasting stations.

Admiral Bullard explained orally that some agitation has resulted because of the recent citation by the Commission of KWKH, Shreveport, La., for alleged use of 3,000 watts of power against the Commission's license authorization of only 1,000 watts.

The correspondent, Admiral Bullard said, charged that the South is being discriminated against in the matter of stations. This is denied by the chairman of the Federal Radio Commission, who points out, in the letter, that the Commission cannot initiate action toward establishing stations there if the people of the South do not want broadcasting stations.

Text of Letter

The full text of the letter follows:

"It must be apparent that the number of stations existing when the Federal Radio Commission came into being was a matter which could not be controlled in any manner whatsoever.

"The Federal Radio Commission is not in any manner acting against the interests of any Southern State in their desire to have broadcasting stations and the Commission cannot accept the statement that the South is being badly treated by the Radio Commission. I assure you that such is not the case, when only last week permits were granted to at least eight new broadcasting stations in the Southern States and not a single one in the North.

Representation Discussed

"The Commission is quite aware of the section of the Radio Act of 1927 which intimates that stations should be allotted on an equitable basis among the states, and that is one of the dominating features of the action of the Commission at this time, and surely a station should not be deprived of its license simply because it does not happen to be in a Southern State.

"It is a fact that the Southern States are not particularly well represented in the broadcasting field, but it is also a fact that this Commission cannot be held responsible for that state of affairs because if the people of the South do not want broadcasting stations and do not make application for them the commission cannot take any action whatsoever.

Admitted Higher Power

"The owner of station WKKH, Mr. W. K. Henderson, at a public hearing before the Commission admitted on the witness stand that his station was operated on a power at least three times that authorized

by the Commission and naturally the Commission had to take official notice of such disregard of the Commission's rule and in accordance with the Radio Act of 1927 this fact may be reported to the Department of Justice with the request that the proper legal steps be taken.

Question of Law

"The Commission as a Commission can take no legal proceedings against any broadcasting operator, but in accordance with the Radio Act must refer such matters to the Department of Justice with the proper recommendation.

"In this case the recommendation was that the owner of this station should be properly disciplined as laid down in the act mentioned."



The new specially treated wood panel of real beauty and merit that meets all panel requirements. Recommended by leading radio engineers. Write for descriptive information.

THE LIGNOLE CORPORATION
508 S. Dearborn St. Chicago, Illinois



Specified for the Victoreen

Among the important details for successful set operation install:

Yaxley No. 10 Midget Switch. Over a million now in use.....	50c each
Yaxley No. 760 Double Pole, Double Throw Jack Switch	\$1.20 each
Two Yaxley No. 416 Pup Jacks.....	2 for 25c

At Your Dealers

YAXLEY MANUFACTURING CO.
9 South Clinton Street, CHICAGO

New!



and Much Better

The prongs are completely enclosed and can't spread. No more socket trouble to shoot!

After all, a socket's only job is to provide a perfect contact. The Eby three point wiping spring contact is the most scientifically perfect type known.

Easy to mount above or below Bakelite, Wood or Metal panel.

Used by leading manufacturers and specified in most of the popular circuits.

List Price 40c

The H. H. Eby Mfg. Co.
Incorporated
4710 Stenton Ave., Phila., Pa.
Makers of Eby Binding Posts

MAR-CO DIALS



—new type, No. 302, illuminated, specified for the new Victoreen. At all dealers.

Victoreen

IT'S RADIO TIME NOW!

Artists of note are tuning their various instruments for wonderful winter programs! Are you ready to receive their offerings? Will you get all the quality they will put into their music, regardless of where they are? If you want to be sure of quality, selectivity, distance and stability—you will build a Victoreen Super—the real sure way to reception satisfaction.



Victoreen Radio Frequency Transformers

No. 170—For Storage Battery Tubes
No. 171—For Dry Battery Tubes

Actually timed to one-third of one per cent., these high precision instruments offer the builders of "Super" Sets the assurance of freedom from oscillation, howls or squeals and a minimum of B Battery consumption. Due to their exclusive construction features, stray fields are eliminated, enabling the transformers to be placed in close relation to each other. Victoreen Transformers have well been called the Heart of the Super Circuit.

PRICE: \$7.00 EACH



Victoreen 112 Audio Transformer Unit

This unit is worthy of its place in the Victoreen Circuit and renders a marvelous offering in tonal quality—presenting all the intimate naturalness of the original program.

Designed to handle up to 400 volts of B Battery supply, this unit is especially adapted to the Western Electric cone speaker or similar types. The transformer consists of two stages of Audio amplification in one case and is designed for use with two 112 power tubes.

PRICE: \$22.00

Write Today for 1928 Blue Print of the Victoreen Circuit



How to Form Condenser at the Right Voltage

(Continued from page 13)

to the plate of the last tube, or a somewhat higher voltage.

Go Beyond

For example, if the voltage applied to the plate is 180 volts, the condenser should be formed at about 200 volts. The voltage drop in the choke coil cannot be subtracted from the applied voltage because when the direct current in the plate circuit is zero

the drop is also zero, and this contingency must be anticipated. If the forming voltage is 200 volts and a capacity of 100 microfarads is necessary, it is possible to get the condenser in a container no larger than the case of a 4 mfd. paper condenser.

A fourth important application of the electrolytic condenser is shown in Fig. 4. It is as the final by-pass condenser in a B bat-

ter is a remedy for low frequency oscillations or "motorboating."

Total Resistance Negligible

In the first place the capacity of the condenser is so large that the effective resistance of the filter and rectifier, when measured from the output binding posts, is negligible for even the lowest frequencies which the set is able to amplify. Since this resistance is the direct cause of "motorboating," the condenser removes the cause. If the condenser is large enough, even the most vicious "motorboater" will be quieted.

Not only does the condenser reduce the cause of "motorboating" directly, but also indirectly.

Since the capacity of the condenser is large it is possible to use a much lower in-

**SELECTED FOR THE
ONE DIAL WITZ**



**Three
FMC
Double
Impedance
Units**

After exhaustive tests of all similar apparatus FMC Double Impedance Units were selected because of their superior tone quality, ease of mounting and general efficiency. Price, per unit

\$600

Ford Radio & Mica Corp.
111 Bleecker St. New York



Specified!

In leading circuits featured by Radio World, CLAROSTAT, the greatest variable resistor, is most always specified.

"THE GATEWAY TO BETTER RADIO." 32 pages covering the latest angles in radio. Send 25c to Dept. R.W., American Mechanical Labs., Inc., 285 N. 6th St., B'klyn.

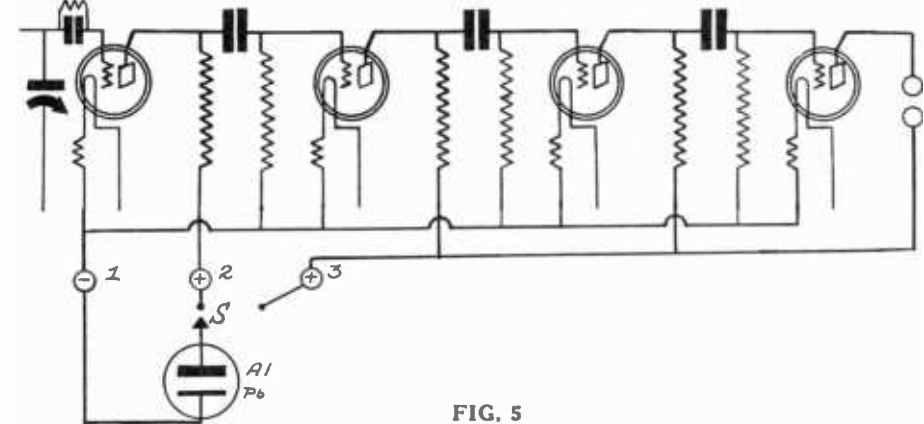

FIG. 5

tery eliminator. The failure of most eliminators with the higher class receiving sets is due to the inadequacy of this condenser. The capacity used ordinarily is not one-tenth that required to prevent low frequency oscillation in the amplifier. The electrolytic condenser placed in that position is the simplest cure for "motorboating."

There are several reasons why this con-

ductance in the choke coil, and only one coil will be necessary to effect satisfactory suppression of all hum. Thus the resistance is greatly reduced by the elimination of one of the chokes and the reduction of the other. Larger wire can also be used in the remaining choke coil, thus still further reducing the resistance.

It is not desirable to use an electrolytic condenser next to the rectifier because only a condenser of about 4 mfd. is desired in that position. This can well be of the paper variety.

The forming voltage of the condenser used in Fig. 4 must be greater than the output voltage of the rectifier when no current is flowing. This might be 50% higher than the voltage across the condenser when the set is in normal operation.

(Concluded on page 29)

IMPROVED TURN-IT



Variable Grid Leak (Non-Evaporating) **\$1.00**
.5 to 12.6 megohms.....

If your dealer can't supply you write direct.
GARDINER & HEPBURN, Inc., 611 Widener Bldg., Philadelphia, Pa.

ELECTRAD

Certified Radio Parts

**Make any Good Receiver
BETTER**



ECC
TUBES

C.E. MFG. CO.
Providence
R.I.

Radio World's CLASSIFIED ADS for Quick Action

10 Cents a Word—10 Words Minimum—Cash With Order

YOU CAN BUILD any set better with the Wingra Tool Kit. Approved by radio engineers. Now buy this bargain direct. 10 tools, \$2 postpaid. Wingra Tool Co., Box 626, Madison, Wis.

DIRECT FACTORY SALE—Wholesale prices. Tremendous Savings. Selling direct to you. Here are some of our many items: 30 Henry Choke, 100 M.A., \$2.19; 10 Henry Choke, 400 M.A., \$5.48. Power Transformers for all kinds of Eliminators and for all types of A.C. Tubes, at Special Low Prices. **EVERY ITEM FULLY GUARANTEED.** Promptly shipped, upon receipt of order. Send for free illustrated catalog today. Todd Electric Co., Inc. (Manufacturers) 36 West 20th Street, Dept. D, New York City.

HOW TO USE AC TUBES. Complete data in the August 6 issue of RADIO WORLD. Sent on receipt of 15c. RADIO WORLD, 145 W. 45th St., N. Y. C.

VALET AUTOSTROP RAZOR—The only razor that sharpens its own blades. Highly polished nickel-plated, self-stropping Valet AUTOSTROP Razor, with one blade, in velvet lined metal case. Leather strap especially prepared, and complete outfit in neat, lithographed carton. Mailed post paid on receipt of 50c. **SPECIAL:** Send \$2 for one-third of a year subscription for Radio World (yearly price \$6), mention this particular ad, and complete "Pal" set will be sent as a premium. If already a subscriber, your subscription will be extended three months. **THE COLUMBIA PRINT,** 145 West 45th Street, New York City.

Do you want to complete your files for Radio World?—Any copy that you missed during the past Summer will be supplied @ 15c. the copy, or any 7 copies for \$1.00, or you can start your subscription with any issue. Circulation Dept. Radio World, 145 W. 45 St., New York City.

DATA ON the new Raytheon rectifier cartridge appeared in the May 21 issue of RADIO WORLD. Send 15c for this issue or begin your sub. with this issue. **RADIO WORLD,** 145 West 45th St., New York City.

COMPLETE DETAILS on what ohmage resistances may be used with B eliminators to also obtain C bias, were given by Frank Logan in the March 12 issue of RADIO WORLD. Either send 15c for his issue or begin your subscription with this issue. **RADIO WORLD,** 145 West 45th St., New York City.

HOW TO BUILD RADIO WORLD'S Four-Tube Universal Receiver fully described by Herman Bernard in the March 12, 19 and 26 issues of RADIO WORLD. Send 45c and get these three numbers. **RADIO WORLD,** 145 West 45th Street, New York City.

(Concluded from page 28)

If the last tube is of the .71-type the total voltage across the output will be about 220 volts. Hence the forming voltage of the condenser should be over 300 volts. It should be pointed out that if the forming voltage is not quite enough, the cell will automatically become formed properly.

Violent and frequent voltage surges will ultimately form the cell to a voltage far in excess of that ordinarily required. This will reduce the capacity of the condenser. Hence in designing the cell it is well to allow for this reduction and employ ample aluminum surface.

The circuit in Fig. 4 applied particularly to the design of a new rectifier-filter.

A Resistance Example

It does not especially apply to an eliminator already built and found to be wanting in connection with certain circuits, nor does it apply to the case of a circuit which "motorboats" with battery supply.

In Fig. 5 is shown a resistance coupled amplifier and how the electrolytic condenser can be connected to it. The resistance coupled amplifier is chosen because it represents a typical "motorboater." The lead plate of the condenser is connected to the negative terminal of the filament battery.

The aluminum electrode is connected to the plus binding post of the receiver.

It makes no difference now whether the set is supplied with a battery or an eliminator. The receiver might flutter at a very slow rate, or it might squeal at a frequency not far from the upper limit of audibility. First try connecting the aluminum plate to the amplifier B plus binding post, marked 3 in the drawing. The high-pitched squeal will stop in every case, and the slow flutter will stop if the condenser is large enough.

Other Ways

But it may be that the frequency is neither high nor very low. It might be between 15 and 100 cycles per second. If the No. 3 position does not stop this trouble try position No. 2. There is still another possible connection which may have to be resorted to in order to stop oscillation. This is to connect the lead plate to position No.

2 and the aluminum to No. 3. The necessity for this does not arise often.

The forming voltage of the electrolytic condenser used in Fig. 5 should be the same as that in Fig. 4, if they are used with similar voltages.

Electrolytic condensers are not difficult to build. A clean sheet of a good grade of aluminum suitably folded to go into the container chosen is one requisite. A rod, strip or sheet of lead is another. The third requisite is a quart or so of saturated ammonium phosphate or borax. A glass jar of suitable dimensions is desirable though a tin can is also a possibility.

To the cover of the jar an insulator should be attached and on this the terminal posts should be mounted. The aluminum is connected to one and marked "plus" and the lead is connected to the other and this is marked "minus." After forming it is also well to mark down plainly the forming voltage.

Set Builders!

Be first to build the new Magnaformer 9-8 Circuit—Commander-in-Chief of the Air—featured by Radio Authority G. M. Best in Sept. and Oct. Radio. Read his articles. See also Sept. and Oct. Popular Radio and C. R. Call Books. Two years ahead of the field. Outstanding feature is its marvelous Tone-Quality. Women, musicians and experts especially are enthusiastic in their praise of its amazing fidelity of tone. The NEW scientifically designed and precisely matched Magnaformer Intermediate Long Wave R. F. Transformers are the cause. Everyone who hears or tunes a Magnaformer 9-8 decides to own one immediately. Beautiful in appearance. Changes from 9 to 8 or 8 to 9 tubes instantly. Great distance getter—super-selective—a world of volume—quiet operating—easy to tune—easy to build. Any one can do it. All standard parts. NO AFTER-SERVICE. The ideal set to build for others. Send NOW for free descriptive literature.

RADIART LABORATORIES COMPANY
19 S. La Salle Street Dept. 67 Chicago

World "A" Power Unit--\$12.75

Automatically provides even, unvarying "A" current from your light socket. Absolutely noiseless. Assures full tone quality from your set and wider D. X. range. Famous WORLD quality—at less than half of the cost of any similar equipment. Shipped complete, subject to inspection on receipt of price, or C. O. D., if you wish. 25 amp. unit for sets of 4 tubes or less, \$12.75. 60 amp. unit for sets of 5 tubes or more, \$15.75. 5% discount if cash in full is sent with order. Send order today. World Battery Co., 1219 So. Wabash Ave., Dept. 82, Chicago, Ill.

BLUEPRINTS OF INEXPENSIVE DX RECEIVERS

THE FIVE-TUBE DIAMOND OF THE AIR, a very selective circuit of thrilling tone quality, that brings in distant stations to the great delight of the fans, is easily built, in fact can be constructed in a couple of hours. The authorized blueprints that make this speed and efficiency possible are just off the press and will be shipped at once, together with a booklet of full textual exposition of construction, including winding of coils, how to connect coil terminals, what values of condensers and resistors to use, etc. If you want a tone quality set that will give you great enjoyment, be sure to build this five-tube Diamond of the Air. The receiver consists of a stage of tuned radio frequency amplification, a specially sensitized detector, first stage of transformer audio and next two stages of resistance audio. It is easily adapted to playing phonograph records on your speaker. Get acquainted with this NEW delight.

THE FOUR-TUBE DIAMOND

represents the most that is obtainable from four tubes. A stage of tuned radio frequency amplification, a specially sensitized detector, and two stages of transformer coupled audio. Follow the diagrams as shown in the blueprint and you can't go wrong. You will be amazed at the results. Build the set from parts that you have. Full instructions cover utilization of such apparatus. Thousands are eager to build an economical set and this one is the most economical in cost of construction and upkeep, where one considers the surpassing results. Works splendidly from batteries, with either type 99 or type 01A tubes, and can be used with A and B eliminators, power packs, etc., with great success.

Look Over Both of These blueprints and read the text in both cases before choosing the receiver you are to build.

SEND NO MONEY!

Just fill out the coupon below, and note what you get FREE!

Guaranty Radio Goods Co.
145 West 45th Street, New York City

Please send me one newly-printed official blueprint of the 5-tube Diamond of the Air, one newly printed official blueprint of the 4-tube Diamond, and the textual data giving full directions for constructing these sets. I agree to pay the postman 75 cents on delivery. Also, you are to send me, without extra cost, one Auto Strop Safety Razor, one blade and one automatic razor strop.

Name

Address

CityState.....

NEW POWERTONE GIANT CONE

(Pedestal Type Speaker)

YOU can build this new, exceptionally fine 36-inch cone speaker in a brief and pleasant half hour from the simple instructions contained in the official Powertone Kit and thrill to the amazing quality and volume reproduction that characterizes the best \$50.00 and \$100.00 factory-made speakers. Low notes come zooming through, full deep and resonant; middle and high notes all realistically reproduced, too. Show your family and friends how you can choose a speaker with expert skill.



SEND NO MONEY!

The Powertone Kit contains one Powertone Cone Unit, two sheets Pomotex diaphragm texture (one front sheet decorated as shown), pedestal, mounting frame and brackets, Du Pont cement, apex shield, set screw, two baffle rings, and full direction sheet.

NEW POWERTONE UNIT \$6.50

Powertone Electric Co.
220 Fulton Street
New York City

POWERTONE ELECTRIC COMPANY
220 Fulton Street, New York, N. Y.

Please send at once complete kit and directions for building the new Powertone 36" Giant Cone Speaker (Pedestal Model) for which I will pay \$12.00 on receipt.

Volume Control for Any Circuit

STANDARD Centralab Radiohm

The exclusive Centralab feature of making contact on a resistance element by a pressure shoe and tilting disc, assures long life and permanently noiseless adjustment. Centralab Radiohms with 2 terminals, and Modulators with 3 terminals, provide gradual, silent control of oscillation or volume.

Centralab Radiohms, with resistance value of 2,000 ohms, are used as stabilizing resistance in Reflex or Superheterodyne. Also used in the RF grid return circuits of tuned radio frequency sets. They provide excellent control of regeneration when shunted across the tickler in such circuits as Browning-Drake, Samson TC, Radio Broadcast, Aristocrat and others employing feedback principle. 25,000 ohms are especially adapted for the S-C circuits. 100,000, 200,000 and 500,000 ohms are the most satisfactory plate circuit resistance for controlling RF oscillation in tuned radio frequency circuits. Also, used to provide volume control.

There is a resistance and correct taper for every circuit, providing a perfect control of the circuit, with simplified panel appearance. Can be smoothly varied throughout their entire range from zero to maximum, and give full resistance variation with a single turn of the knob. Non-inductive; no sliding contacts carrying current. Exact resistance values are maintained as adjusted.

Resistances 2,000, 25,000, 50,000, 100,000, 200,000, or 500,000 ohms, \$2.00. 200,000 and 500,000 ohms, with "A" battery switch combined in the one unit, \$2.30.

Centralab Modulator

The ideal panel-mounted volume control. Has 3 terminals and a special taper of resistance to provide smooth, noiseless volume control from a whisper to maximum. A sure cure for overloaded tubes and harsh amplifiers.

Resistances 250,000 or 500,000 ohms..... \$2.00
500,000 ohms, with "A" battery switch combined in one unit..... \$2.30

At your dealer's, or C.O.D.

Central Radio Laboratories
113 Keefe Avenue Milwaukee, Wis.

Centralab

RADIO AT WHOLESALE

Write for my Big 1928 Radio Catalog—just off the press. Thousands of marvelous bargains in nationally advertised goods. All the LATEST IN RADIOS and equipment. Lowest wholesale prices. Agents Wanted.

It's a regular encyclopedia on Radio. All about trouble finding. **FREE Log and Call Book and Catalog.** Get your copy today. Send postcard now!

American Auto & Radio Mfg. Co.
HARRY SCHWARTZBERG, PRES.
Dept. 193, American Radio Bldg., Kansas City, Mo. 3

DEALERS NEW 1928 CATALOG

LYNCH METALLIZED FIXED RESISTOR

Frost Reports Surprises of His European Trip

Major Herbert H. Frost, former president of the Radio Manufacturers' Association, and now sales manager of E. T. Cunningham, Inc., who returned from Europe after conferences with leading radio interests of England and France, found some features of European broadcasting somewhat strange.

"Each French set seems to be different from all other receivers in that country," stated Major Frost. "There appears to be no agreed-upon method of control devices, as we know them.

"There is little or no desire on the part of the French people to hear American programs as broadcast across the Atlantic. This is in contrast with the attitude of British fans.

American Sets Rebuilt

"American-made sets are generally rebuilt for British wavelength range. British-made sets evidence a great deal of care in the design of cabinets, method of control, etc.

British-made parts are exceptionally well made and are correctly designed, both electrically and mechanically.

"The British tradespeople in the radio field feel confident that television will come into general usage and that trans-Atlantic broadcasting is just around the corner. In this they are keenly interested and eagerly await the time when they can hear American stations and also let Americans hear the British programs in which they take so much pride.

"I was surprised to learn that there is considerable interference due to wavelengths used by some of the stations located in the various small nations who have not entered into the Geneva plan of control.

"Spain is declared to be the worst offender, and various opinions are given as to why the Spanish Governor withholds membership in this supporting plan of control. The situation is described as political.

Interest Varies

"No great amount of interest is shown in radio by the ordinary Frenchman in Paris. In the rural districts, however, there is an ever-growing interest, due to broadcasting of market reports, live stocks, prices, etc., which have actually brought greater prosperity to the French farmer.

"This situation is resented by the Paris Frenchman, who lets it be known in no uncertain terms that all the radio has done is increase the cost of living.

"The ever-increasing number of English-speaking visitors to France has made a knowledge of the English language one of the Frenchman's most valuable assets and a series of English lessons put on by a Paris station has done much to make the radio better known.

The LOGICAL Filament Control

AMPERITE is the only self-variable filament control. Automatically does the work of hand rheostats and delicate meters. Proved for 6 years. Specified in every circuit. Entirely different from fixed filament resistors. Accept nothing but AMPERITE, FREE—"Amperite Hoc" of the season's best circuits and latest construction data. Write Dept. BW20.

RADIALL COMPANY
60 Franklin St., New York

AMPERITE
RES. U.S. PAT. OFF.

The "SELF-ADJUSTING" Rheostat

\$12.50

Complete



Use your Radio to electrify your phonograph—attach the Pacent PHONOVOX

YOU WILL experience a revelation in phonograph reproduction when you have heard your favorite records reproduced through the Pacent PHONOVOX—a better phonograph pick-up device.

Ask your dealer to demon-

strate this greatest radio-phonograph accessory of the year! See how easily and quickly it is attached—without tools or changes in wiring! He will gladly show you how you can secure the equivalent of electric phonograph reproduction at a cost of only \$12.50.

Sold and demonstrated by dealers everywhere

PACENT RADIO CORPORATION

156 West 16th Street

New York

Makers of the famous Pacent Balanced Cone

150 Miles Covered in Ground To Plane Test

Washington. Ground-to-plane conversation was maintained over a distance of 150 miles in a recent flight to test radio telephonic communication, according to a statement just issued by the Bureau of Standards, Department of Commerce.

"Though not a record," G. C. Gross, junior physicist in the radio laboratory of the Electrical Division, stated, "150 miles is close to the limit for air conversation with the equipment now obtainable. It was made under the most favorable conditions.

"Telephonic communication," Mr. Gross said, "is a third means of directing planes on the proper course. The other two are the radiobeacon and the markerbeacon. The radiobeacon is directive, that is, the pilot follows the airway course by merging two differing signals of the beacon along the airway into a series of dashes, the letter 'T' in Morse.

Serve as Mileposts

"The markerbeacons serve as mileposts and are set at intervals along the course. The pilot gets their signal for a period just before he passes over. The radio telephone provides a means of giving the pilot weather conditions, changes in orders, and other information."

The radio test flights were made by the Bureau of Standards in cooperation with the Post Office Department, using post office airplane 630 at Bellefonte, Pa. The Bellefonte station is similar in equipment to the College Park (Md.) station, also conducted

by the Bureau, but has the advantage of lying directly in the path of the New York-Cleveland air mail service.

Put on Regular Run

This airplane was placed on the regular air mail run between Cleveland and New Brunswick, N. J., equipped for radio telephonic communication with a range of approximately 100 miles from Bellefonte.

The Bellefonte radio station broadcasts weather and other information to this plane. This station is located about four and one-

half miles from the Bellefonte field and is remotely controlled from the hangar office, enabling the personnel there to broadcast information without interfering with radio reception at that point.

HOW OLD IS RADIO?

Guglielmo Marconi, the Italian inventor, discovered the principle of wireless telegraphy in 1895, when but twenty-one years of age. The Marconi Wireless Telegraph Company of America was the first company in America formed for the purpose of engaging in the transmission of messages by wireless. It was organized November 22, 1899, with a capitalization of \$10,000,000, of which 25 per cent was owned by the Marconi's Wireless Telegraph Company (Ltd.), a British corporation.

KARAS Parts Enable the NEW "KNICKERBOCKER 4"

To Deliver Truly Amazing Results

THE WONDER RECEIVER

THERE is no question about results when you build the KNICKERBOCKER 4 described and illustrated in detail in RADIO WORLD. It surely steps out and delivers! This marvelous new 4-tube receiver has all the volume ordinarily expected from a 5 or 6-tube set. Its tone is rich, powerful, sonorous and clear as a bell. As a distance getter it is a wonder. In selectivity it equals the finest super. And for ease of tuning and simplicity of operation you can't beat the KNICKERBOCKER 4; it is in a class all by itself.

Why is the KNICKERBOCKER 4 So Much Better?

The circuit used in the KNICKERBOCKER 4 is new—different—better than any other 4-tube circuit ever designed. And simpler. Instead of having to make adjustments in the detector circuit with an extra control, this is automatically accomplished with the dial of the tuning condenser in this circuit. The turning of this dial gives absolutely hair line adjustment of the Karas 3-Circuit Inductance and Karas Condenser both at one time. There never was such a circuit for simplicity of operation—ease of tuning—satisfactory results.

Karas Parts Are Vital to Its Success

The KNICKERBOCKER 4 was built around Karas Parts and no others will give you the same results, so be sure to use the following Karas Parts when you build this set:

- 2 Karas Orthometric S.F.L. Extended Shaft .00037 mfd. Variable Condensers.
- 2 Karas Harmonik Audio Transformers.
- 1 Karas Equamatic Inductance Coil.
- 1 Karas 3-Circuit Inductance.
- 2 Karas Micrometric Vernier Dials.

Your dealer can supply you with these Karas parts and the other standard parts you will need to build this receiver. Begin to build it today. You know the quality and straight frequency line characteristics of Karas Orthometric Condensers—the splendid volume and purity of tone provided by Karas Harmonik Transformers—the reliability of Karas Inductance Coils and 3-Circuit Inductances—and the 1-1000th of an inch control furnished by Karas Micrometric Vernier Dials. So be sure to order these Karas parts, so as to make sure of 100 per cent performance of your KNICKERBOCKER 4.

Write for complete, detailed information about the KNICKERBOCKER 4—wiring instructions—everything you need in the way of information. Mailed free on request. Address

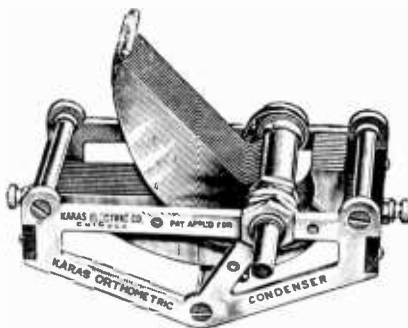

2 Karas Orthometric Extended Shaft .00037 mfd. Variable Condensers are used in the KNICKERBOCKER 4. Price, each, \$7.00.



2 Karas Harmonik Audio Transformers give the KNICKERBOCKER 4 its tremendous volume and purity of tone. Price, each, \$5.

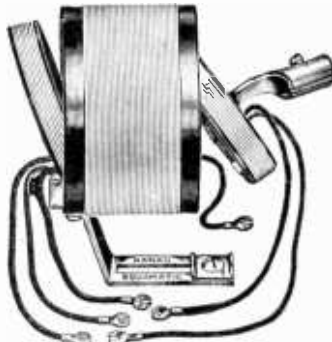

1 Karas 3-Circuit Inductance, price \$5.50 (this 3-Circuit Inductance is the heart of the KNICKERBOCKER 4)
1 Karas Equamatic Inductance Coil. Price, \$4.00.



2 Karas Micrometric Vernier Dials, price, each, \$3.50, give the KNICKERBOCKER 4 1-1000th of an inch tuning control.

KARAS ELECTRIC COMPANY
4039-1C North Rockwell Street, Chicago, Ill.

For the Latest and Best in Radio Get MILLER-WELLES NEW 1928 CATALOG—IT'S FREE
KNICKERBOCKER 4
Just as described in this issue, ready for shipment. Kits for all popular receivers in stock and described in our catalog. Write today.
MILLER-WELLES CO.
18-R West Kinzie St. Chicago

SAMSON

85 Millihenry RF Choke...\$2.00

Neutralizing Condenser, .00003 to .0003 mfd.... 2.25

Specified in the

"KNICKERBOCKER 4"

SAMSON ELECTRIC CO.
CANTON, MASS.

Subscribers: Look at the Expiration Date on Your Wrapper

We do not like to take your name from our subscription list without specific instruction to do so, because many of our readers wish to keep a complete file of the paper.

Please therefore, look at the subscription date stamped on your last wrapper, and if that date is earlier than the issue contained in the wrapper, please send check to cover your renewal.

In this way you will get your copies without interruption.

Subscription Dept, RADIO WORLD, 145 W. 45th Street, New York City.

